

12-15-2014

# An Engineering Approach for the Design of Archaeological Reburial Systems

Angel Ari Perez Mejia

University of South Carolina - Columbia

Follow this and additional works at: <https://scholarcommons.sc.edu/etd>



Part of the [Civil Engineering Commons](#)

---

## Recommended Citation

Perez Mejia, A. A. (2014). *An Engineering Approach for the Design of Archaeological Reburial Systems*. (Doctoral dissertation). Retrieved from <https://scholarcommons.sc.edu/etd/2928>

This Open Access Dissertation is brought to you by Scholar Commons. It has been accepted for inclusion in Theses and Dissertations by an authorized administrator of Scholar Commons. For more information, please contact [dillarda@mailbox.sc.edu](mailto:dillarda@mailbox.sc.edu).

AN ENGINEERING APPROACH FOR THE DESIGN OF ARCHAEOLOGICAL  
REBURIAL SYSTEMS

by

Angel Ari Perez Mejia

Bachelor of Science  
Universidad Tecnológica Centroamericana, 2006

Master of Science  
University of South Carolina, 2011

---

Submitted in Partial Fulfillment of the Requirements

For the Degree of Doctor of Philosophy in

Civil Engineering

College of Engineering and Computing

University of South Carolina

2014

Accepted by:

Charles Pierce, Major Professor

Sarah Gassman, Committee Member

Joseph Flora, Committee Member

Jonathan Leader, Committee Member

Lacy Ford, Vice Provost and Dean of Graduate Studies

© Copyright by Angel Ari Perez Mejia, 2014  
All Rights Reserved.

## DEDICATION

To my family, and friends who supported and helped me through this process and my professors, both at USC and at UNITEC, who were kind enough to share their knowledge with me.

I would like to thank my father and paternal grandparents who gave me the motivation to come to South Carolina and provided help and support during my time here.

I would also like to give special mention to my mother, Dr. Lisette Mejia who has never left my side, and to my step father, Claude Lombard that I hold in very high esteem. I would also like to thank my grandmother, Orfilia de Mejia, who has been a driving force in my studies and my career.

Most of all, this work is dedicated to my grandfather, Aristides Mejia Castro (May his soul rest in peace), who was truly the best father one could hope for and whom I loved dearly, and miss every day.

## ACKNOWLEDGEMENTS

I would like to thank Dr. Pierce for his help during the research process and throughout my time in graduate school. I would also like to thank the rest of my committee for their help throughout the dissertation process. A special acknowledgement is due to Dr. Leader in SCIAA for the help he provided with the archaeological component of my dissertation. Dr. Smith in SCIAA, and Dr. Kelly in the archaeology department also gave me crucial help in this regard.

I would also like to thank SEAGEP for the funding they provided me throughout my time in graduate school and without whose support I would not have been able to perform this research.

Lastly, I would also like to thank the staff members of the Civil Engineering department who have always been friendly and helpful, and who made my time in graduate school much easier.

## ABSTRACT

Archaeological sites are a non-renewable resource which is often our only link to the past. However, sites are under constant threat of destruction due to construction activities. Civil engineers and archaeologists must work together to ensure both the continued survival of archaeological sites while allowing for development to continue.

Reburial systems, when properly designed and constructed, allow for the protection of archaeological sites while allowing the continued use of the land. However, because reburial as an intentional conservation technique is relatively modern, practice is fragmented and there are no universally accepted guidelines.

Current reburial system design relies on prescriptive guidelines scattered through the literature, and is often undertaken on a site by site basis. Because of this approach, reburial systems can often have ineffective or counter-effective performance.

A quantifiable design process which takes into account the archaeological preservation needs and the engineering demands placed on a site is necessary to standardize reburial system design. A set of guidelines for design is presented in this document.

## TABLE OF CONTENTS

Dedication.....	iii
Acknowledgements.....	iv
Abstract.....	v
List of Tables .....	viii
List of Figures.....	x
Chapter 1 Introduction .....	1
1.1 In-situ conservation of archaeological sites .....	1
1.2 Reburial system design.....	2
1.3 Research questions.....	5
1.4 Document structure .....	6
Chapter 2 Background .....	8
2.1 Archaeological sites .....	8
2.2 Legal framework .....	17
2.3 Reburial literature review.....	26
Chapter 3 Reburial System Classification .....	48
3.1 Reburial as a method of in-situ conservation of archaeological sites .....	48
3.2 Previous archaeological reburial experiments.....	51

3.3	Reburial covers.....	67
3.4	Reburial cover materials.....	79
3.5	Reburial system taxonomy.....	81
Chapter 4 Design Method.....		90
4.1	Current design challenges.....	90
4.2	Design philosophy.....	94
4.3	Current state of design for reburial systems.....	100
4.4	Basis for the DAISEE method of reburial system design.....	116
4.5	Decay processes of archaeological material.....	117
4.6	Design Methodology.....	131
4.7	Layer design.....	138
Chapter 5 Design Examples.....		214
5.1	Pre-design considerations.....	214
5.2	Design process.....	217
5.3	Design Examples.....	228
Chapter 6 Conclusions and Recommendations.....		236
6.1	Conclusions.....	236
6.2	Future Work.....	240
6.3	Recommendations.....	242
References.....		245



## LIST OF TABLES

Table 2.1 Federal Legislation for Archaeological Site Preservation .....	21
Table 2.2 Categorization of ASCE Publications related to Archaeology (1986-2012)....	29
Table 2.3 Summary of Conferences with a focus on geotechnical engineering and archaeology .....	31
Table 2.4 Summary of selected collaborations between archaeologists and engineers (based on Tilly 1998). .....	36
Table 3.1 List of reburial projects.....	68
Table 3.2 Overview of the reburial systems and their components.....	82
Table 3.3 Potential damage sources and conditions .....	85
Table 4.1 Current design challenges and solutions.....	94
Table 4.2 Proposed values for damage coefficients.....	121
Table 4.3 Proposed shape coefficients for glass and ceramic.....	123
Table 4.4 Description of site sensitivity ranges .....	123
Table 4.5 Summary of available information for computing of sensitivity factors from the literature .....	125
Table 4.6 Different archaeological value factors for the computation of prioritized sensitivity factors .....	127
Table 4.7 Constants for peak shear stress calculations (from Gilbert et al. 1996) .....	145
Table 4.8 Values of bedding constant K (from Qian et al. 2001).....	153
Table 4.9 Average values of soil reaction modulus for short term flexible pipe deflection (from Qian et al. 2001).....	153
Table 4.10 Allowable deflection ratio of polyethylene pipe (from Qian et al. 2001).....	155

Table 4.11 Important engineering properties for fill material and corresponding testing methods.....	166
Table 4.12 Engineering properties of fill materials .....	175
Table 4.13 Representative values of Poisson’s ratio (from Das 2002).....	192
Table 4.14 Representative values of the modulus of elasticity of soil (from Das 2002)	192
Table 4.15 Influence factors for foundations (based on Schleicher 1926).....	192
Table 4.16 Common monitoring parameters and susceptible archaeological material. .	206
Table 5.1 Considerations to be made during the assessment stage (based on Demas 2004). .....	216
Table 5.2 Considerations that may apply if reburial is chosen as the conservation options (Demas 2004).....	216
Table 5.3 Assemblage present in an imaginary archaeological site. ....	218
Table 5.4 Sensitivity factors for load, pH, redox, and O2. ....	219
Table 5.5 Prioritized sensitivity factors for load, pH, redox, and O2.....	219
Table 5.6 Inputs, outputs, and design constraints for the DAISEE guidelines.....	220

## LIST OF FIGURES

Figure 2.1 European countries with a large amount of archaeological sites. ....	10
Figure 2.2 Overuse of the underground space in large settlements may threaten the survival of the archaeological material (from Williams and Butcher 2006). ....	11
Figure 2.3 Different possible layouts for excavations .....	15
Figure 2.4 A timeline of important events in the reburial movement. Although reburial was performed prior to The Rose, projects were seldom designed and relied more on covering the area with soil .....	27
Figure 2.5 Annual archaeology related publications in ASCE journals .....	30
Figure 2.6 Plan of the Rose Theatre site. The approximate viewpoint of Figure 2.9 is indicated by the star on the drawing (from Wainwright 1989).....	40
Figure 2.7 Plan of the Rose Theatre. This drawing shows the plies as originally proposed and the extent of modern damage (from Bidden 1989). ....	41
Figure 2.8 This schematic shows the reburial system originally installed at the Rose Theatre (from Ashurst et al. 1989).....	42
Figure 2.9 Picture of the Rose Theatre building as it stands now (Picture taken in June 2012). The door on the bottom right hand leads to the basement where the theatre remains are preserved. ....	43
Figure 2.10 The leftmost figures illustrate the Theatre Trust scheme, and the rightmost figures show the developer's scheme, which was put into place (from Biddle 1989).....	45
Figure 3.1 (from Agnew et al., 2004). Summary of the reburial experiments at Fort Selden, New Mexico.....	54
Figure 3.2 Proposed triaxial test with an archaeological inclusion (from Sidell et al. 2004). ....	59
Figure 3.3 Vibrational patterns from: a.) auger piling, b.) vibro-compaction, and c.) drop-hammer piling (from Sidell et al. 2004).....	60

Figure 3.4 Decision making process for reburial (modified from Demas 2004).....	62
Figure 3.5 Schematics of General Use Reburial Systems. The clean sand reburial system is shown in 1.a, as are the U.K. common practice (1.b) and US common practice (1.c).....	70
Figure 3.6 Schematics of Mosaic Reburial Systems, either horizontal (2.a) or vertical (2.b).....	73
Figure 3.7 Schematics of Site Specific Reburial Systems. The original reburial system installed at the Rose is shown in 3.a, while the proposed system is shown in 3.b. Schematics for the Bristolkvartalet system (3.c) and the second Shardlow boat (3.d) are shown.....	74
Figure 3.8 Wall and pillar foundation of a vaulted room in the medieval ruins at Bristolkvartalet. The exposed remains of the ruins can be seen as they were before the reburial system was put into place (from McLees 2008).....	77
Figure 3.9 Close up photograph of the top of the transom of the second Shardlow boat (from Williams et al. 2008).....	79
Figure 3.10 Proposed classification for reburial systems. ....	84
Figure 3.11 Classification of selected reburial systems.....	88
Figure 4.1 NASA engineering design process.....	95
Figure 4.2 Decision making process for reburial of archaeological sites (from Demas 2004).....	106
Figure 4.3 Factors and guidelines for evaluating reburial systems (from Bilsbarrow 2004) .....	108
Figure 4.4 Qualitative assessment of severity of conditions for the protection of buried archaeological material (Mathewson and Gonzalez 1988).....	110
Figure 4.5 Effect of soil characteristics on the decay rate of various archaeological materials (from Mathewson 1988).....	111
Figure 4.6 Schematic process-time relationships for forest succession and archaeological site decay. In (A) and (D), the independent variables are uniform and the process-time relationship follows a smooth curve. A significant external, independent variable, fire in (A) causes an abrupt step function change in the process-time relationship. Non-uniform or cyclic changes in the value of the independent variables cause irregular process-time relationships. Changes can increase decay (E) or that retard decay (F) (from Mathewson 1989a). ....	118
Figure 4.7 Determination of the material factor for the computation of prioritized sensitivity factors .....	128

Figure 4.8 Model of a “standard” reburial system .....	131
Figure 4.9 Functions of common geosynthetic materials (Kavazanjian 2004, from Bouazza 2002) .....	132
Figure 4.10 Laboratory developed curves showing improvement in bearing capacity of soils using geotextiles; $p$ is the footing settlement and $B$ is the footing width. On the left, (a) was developed using non-woven geotextiles spaced 140 mm on a loose sand ( $DR = 50\%$ ) with a square footing. On the right, (b) was developed using geotextiles spaced 40 mm on a soft saturated clay using a round footing (from Koerner 2005).....	159
Figure 4.11 Load versus deflection curves for soils with and without geogrid reinforcement .....	160
Figure 4.12 Water content-dry density relationships for eight soils compacted according to the standard proctor method (from Holtz and Kovacs 1981) .....	168
Figure 4.13 Commonly used fill materials for the reburial of mosaics (from Roby 2004) .....	169
Figure 4.14 Stress due to fill weight with depth .....	177
Figure 4.15 The 2:1 approximation for the distribution of vertical stress with depth (from Holtz and Kovacs 1981).....	178
Figure 4.16 Required depth of fill for a given stress dissipation ratio. The graph is unitless, but consistent units need to be used for load and depth.....	180
Figure 4.17 Required depth of fill for a stress of only 25 kPa at the archaeological layer for a strip load.....	181
Figure 4.18 Required depth of fill for a stress of only 25 kPa at the archaeological layer for a rectangular or square load .....	182
Figure 4.19 Required depth ratio for stress dissipation of a foundation with $B=1$ .....	183
Figure 4.20 Required depth ratio for stress dissipation of a foundation with $B=2$ .....	184
Figure 4.21 Required depth ratio for stress dissipation of a foundation with $B=4$ .....	185
Figure 4.22 Failure modes for shallow foundations in sand (from Vesic 1973) .....	187
Figure 4.23 General shear failure zone for a foundation (from Das 2010).....	189

Figure 4.24 Required fill height to ensure both adequate stress dissipation and protection of the archaeological material from bearing capacity failure. $zSD$ may be calculated using the 2:1 method discussed above, and $zBC$ will depend on the site conditions, but should be smaller than $3B$ .	190
Figure 4.25 Monitoring plan at the Rose Theatre (from Corfield 2004)	203
Figure 4.26 Comparison among transducers for remote measurement of temperature in geotechnical engineering (from Dunicliff 1993)	208
Figure 4.27 Major factors affecting measurements with embedment earth pressure cells (from Dunicliff 1993).	210
Figure 4.28 Categories of instruments for measuring deformation (from Dunicliff 1993)	212
Figure 5.1 Design process for a reburial system using the DAISEE guidelines	217
Figure 5.2 Proposed reburial system for the second Shardlow boat using the DAISEE guidelines	232
Figure 5.3 Proposed reburial system for an artificial site based on the Topper site using the DAISEE guidelines	235

## CHAPTER 1 INTRODUCTION

### 1.1 In-situ conservation of archaeological sites

Archaeological sites are non-renewable resources and a tangible link to our past (Nickens 1991a; b). Often, they are the only sources of information available to us from a past culture. Moreover, once an archaeological site has been destroyed, the information it could have yielded about the past is destroyed with it.

The destruction of archaeological sites is an ongoing process. Although archaeological sites exist in a constant state of decay, if they are in a stable environment, the decay processes can be slowed down enough so that sites have a long life. However, the present rate of construction in urban areas introduces a new threat to the survival of archaeological sites, as previously undeveloped areas are used for construction. Because modern construction often places high demands on a site, the survival of archaeological remains post-construction can be difficult. Underground crowding, heavy applied loads from overlying construction, and groundwater fluctuations can all negatively impact the archaeological material.

Historically, the focus of archaeological excavations was on the archaeological material itself. Because of this, sites were seen as containers for the archaeological material, with little value themselves. However, as archaeological interpretation has moved to place a

focus on the relationship between the archaeological material and its context, there is a new importance placed on the archaeological site itself. Where previous archaeological excavations were content with recording and removing the finds, modern sites seek to give a holistic interpretation by employing both site and contents.

This can be seen in a shift towards in-situ conservation of archeological sites. Previously, where an archaeological site was threatened with destruction, the accepted common practice was to engage in “conservation by record”. This meant a full excavation of the site, and the removal of the archaeological material. After the remains had been retrieved, recorded, and removed; the site was left without a conservation plan being put into place. Any subsequent activity taken at the site would take its toll on the remaining archaeological material, as no preservation plan was pursued following conservation by record. In extreme cases (such as the London Mithraeum), large archaeological features (in this case the foundations of a Roman temple) were removed completely and moved to a new location to facilitate new construction.

Current preferences for archaeological site conservation are strongly in favor of in-situ conservation. Although in-situ conservation is often accompanied by the display of the archeological site, it’s not a necessary component. Sites in which display is unwanted or impossible can still be protected by in-situ conservation of the remains.

## **1.2 Reburial system design**

Although there are many ways to engage in in-situ conservation, all of them present benefits and downsides. One of the major hurdles for in-situ conservation is that these schemes tend to be costly, as there are maintenance costs associated with the site. Although



these can be defrayed by the income generated from display, oftentimes the costs associated with display are higher than the income generated. Archaeological remains which are left exposed to the elements will require periodic evaluation of their condition, accompanied by restoration if necessary, and a security system. These are periodic expenditures which can greatly impact a project's budget.

The reburial of archaeological remains offers an attractive alternative for in-situ conservation. The idea behind reburial is to return the archaeological material to a stable underground environment which will slow down the natural decay processes affecting the material. Although the decay processes cannot be completely stopped, reburial systems are constructed to mitigate the damage, imitating or improving the medium in which the archaeological material was initially deposited, and later found.

The benefits of reburial for the conservation of archaeological sites are many. First, the archaeological remains are placed in a protected environment, which slows down their deterioration. By reburying the archaeological material, it is also protected from a host of other potentially damaging processes such as anthropogenic activity at the surface (vandalism, looting, etc...), and natural processes brought on by exposure to the elements (such as erosion). Second, reburial allows for use of the site. Reburial systems can protect the archaeological material from activity at the surface, be it construction or agricultural cultivation. This gives reburial systems an advantage in crowded urban settings as it both protects the archaeological material, and allows for development. Third, reburial systems have an inherent flexibility which is well suited for archaeological practice. Reburial systems can be adapted for any size and depth of excavation, and can be applied to an entire site or to a section of the site. Reburial can be undertaken at fully excavated, partially

excavated, and unexcavated sites. Reburial systems can be temporary or permanent, and are constructed to be easily removed. Although it falls outside the scope of this document, maritime reburials (reburials on the seabed) have been used successfully to protect shipwrecks.

Although the use of reburial as an in-situ conservation technique is relatively recent, there are recorded cases dating to the 19<sup>th</sup> century of reburial being used. The 1930 Athens conference recommended reburial as the preferred alternative for in-situ conservation (Demas 2004). However, these were very basic interventions (they consisted of simply replacing the excavated material into the open excavation, without designing a protective environment) which may be better described by the word “backfilling”.

There is some confusion in the terminology used for reburial. Common terms are “reburial scheme”, “burial-in-place”, and “backfilling” all used somewhat interchangeably to denote the same conservation treatment. For the sake of consistency, in this document a “reburial system” is a designed system having multiple components, all working to provide an effective conservation environment for the archaeological material. Backfilling is understood then as the simple act of placing soil into an open excavation, for the purpose of providing an even surface and applied without thought for the conservation of the archaeological material.

Although reburial is a widely practiced conservation treatment, there currently is no design procedure for reburial systems. Furthermore, archaeologists often construct reburial systems without the input of engineers, which leads to more difficulties. Due to this, reburial systems can often be ineffectual, or even damaging to the archaeological material.

To ensure the success of reburial as an in-situ conservation option, more quantifiable research is required. This necessitates the cooperation of both archaeologists and engineers, as a proposed design procedure should account for both the engineering performance standards needed at the site and the conservation of the archaeological material protected under it.

### **1.3 Research questions**

The following research questions guided the work presented in this document:

a.) How can the current state of collaboration between the archaeological and engineering communities be summarized and how should the communities work together?

Because civil engineers are often responsible for the first discovery of a site, they are often involved in the preservation process of archaeological sites. In order to optimize the in-situ conservation process, engineers and archeologists need to collaborate to agree on a solution palatable to both parties. However, the current extent of collaboration is unknown. As archaeological sites are threatened due to the spread of development, legal protections are afforded to them so that they may be preserved. These are critical to in-situ conservation of archaeological sites as they both provide the mechanism through which conservation of the site is undertaken, but also outline the responsibilities of the engineers to archaeological sites.

b.) How are reburial systems categorized and how should reburial systems be described and classified?

Currently, most reburial systems are site-specific designs, Because of this, there is high variability in how reburial systems are designed and constructed. Currently, reburial systems are classified based on intended length of reburial. A better taxonomy must be used in order to facilitate classification of reburial systems.

c.) What is the state of practice regarding reburial systems, and how does it compare to the state of the art?

Currently, constructed reburial systems are based on common practice, or designed on a site by site basis. Because there is no accepted design method for reburial systems, certain designs provide ineffective or counter-effective performance. However, there have been published recommendations for the design of reburial systems.

d.) How should reburial systems be designed and which guidelines should be followed?

Reburial systems need a quantifiable design approach that takes into account the preservation needs of the archaeological assemblage, the engineering demands placed on the site, and site properties. Current knowledge only provides scattered qualitative guidelines for the design of reburial systems. A comprehensive set of design guidelines is needed.

#### **1.4 Document structure**

In this document, the current state of reburial is analyzed, and a set of design guidelines are proposed. Chapter 1 is an introduction to both reburial as an in-situ conservation technique and gives an overview of the state of reburial.

Chapter 2 is the background chapter. In it, a short background on the excavation of archaeological sites is presented, followed by discussion on the state of collaboration between archaeologists and engineers, as well as the legal framework in which reburial operates. The chapter also presents a review of the available literature on reburial, with a focus on the Rose Theatre reburial system.

Chapter 3 discusses the classification of reburial systems. Currently, there is no classification system for reburial systems. Oftentimes, reburial systems are grouped into temporary or permanent, which is a division which is often blurry and liable to change. A proposed classification system which ties into reburial system design is proposed. This chapter also presents notable case histories from reburial projects

Chapter 4 introduces the design method. The rationale for the proposed design guidelines is discussed, as well as the existing design guidelines from the published literature. In depth discussion of a new design method (DAISEE: Design of Archaeological InfraStructure for Elective Entombment) is provided, as well as discussion of each alternative within the DAISEE guidelines.

Chapter 5 provides a step-by-step description of the DAISEE method, as well as some examples of the method applied to the case histories discussed in Chapter 3.

Chapter 6 presents the conclusions and recommendations derived from the work presented in this document. The future research necessary for a complete reburial system design procedure is also discussed.

## CHAPTER 2 BACKGROUND

### 2.1 Archaeological sites

Archaeological sites are recognized as limited and non-renewable cultural resources (Nickens 1991b) which continue to be discovered and explored around the world. The archaeological materials buried within these sites can be of great cultural significance, but the process of exploration and preservation is challenging in these fragile and complex environments, especially in high population areas with substantial development. The harvesting of archaeological sites by excavation and study is inherently destructive. Once a site has been excavated, reconstruction is impossible and contextual information that is derived from the relative location of objects is lost.

Archaeological sites are of immense value because of the dual purpose they serve. First, they better our understanding of our past by revealing information where written records are unavailable or incomplete. In certain cases, information derived from archaeological evidence comprises the vast majority of the knowledge base for that topic. Second, excavation being a procedure which can only be learned by practice, unexcavated sites are necessary for the training of future scholars. From a societal perspective, the exploration and research of archaeological sites is important because it contributes to new knowledge that enhances our evolving cultural understanding of civilized societies, past and present.

However, such field studies must be conducted in a careful and controlled manner to mitigate damage to archaeological materials (e.g., artifacts and structural features) buried within these fragile environments. Archaeological materials can be highly sensitive to small physical, mechanical, and chemical changes within their surroundings. The archaeological context (the position of archaeological material within the soil stratigraphy and its spatial relationship to other materials) is just as important and sensitive to change as the condition of the materials themselves. Changes in ground conditions can arise from increases in overburden stress, settlement, lateral displacement, vibrations, drilling and sampling, and soil removal (e.g., excavation). Changes in groundwater level and chemistry (pH, redox potential, and dissolved oxygen) can directly affect archaeological materials and/or promote growth of harmful micro and macro-organisms. For these reasons special care must be taken to preserve as many archaeological sites as possible.

Over the last 150 years, the spread of urbanization and land development has added another dimension to this problem. Due to this relatively recent trend, unconstructed land is becoming a rare commodity in areas with a high population density. Oftentimes, these areas are also associated with a long history of continued settlement. Europe in particular has come to face this problem as the larger and older cities such as Rome and Athens, must balance the ongoing construction of newer and taller buildings with the duty to preserve archaeologically significant remains. The short life span of modern buildings, often designed to serve for fifty or one hundred years, complicates conservation of sites as every building project takes its toll on the site. Repeated construction projects ultimately ensure the complete destruction of the archaeological material. Figure 2.1 highlights areas in Europe where rapidly expanding urbanization presents a threat to the conservation of

archaeological remains. Although the problems are presently found in large cities, it is possible that in the future archaeological sites which are for now safe because of their location may be threatened.

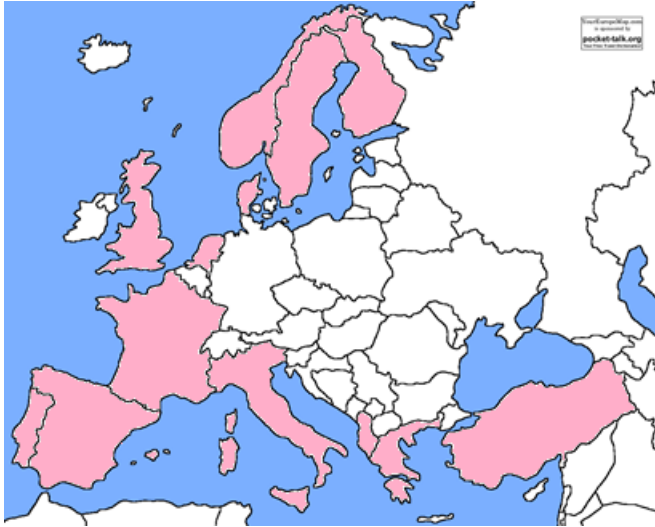

Figure 2.1 European countries with a large amount of archaeological sites.

High density urban areas also suffer from underground crowding due to infrastructure construction. As new technology is developed, existing infrastructure is often updated or added. This construction often takes place underground. Repeated use of the subsoil for different infrastructure needs (such as transportation tunnels or service pipes) crowd the underground space. By overusing this space, we are threatening to destroy the archaeological layer and the information and material contained therein. Figure 2.2 (from Williams & Butcher, 2006) shows an example of underground overcrowding threatening the preservation of the archaeological layer.



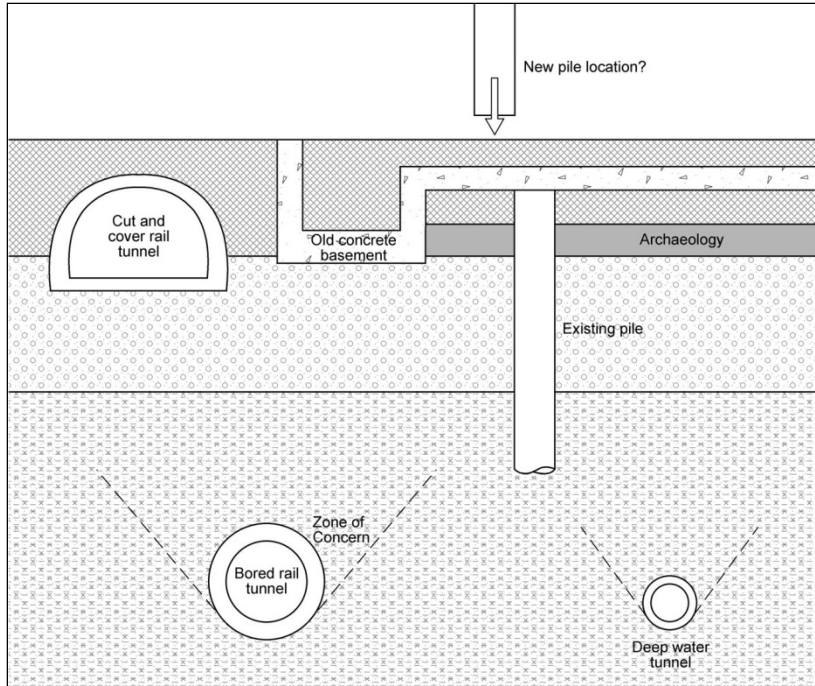

Figure 2.2 Overuse of the underground space in large settlements may threaten the survival of the archaeological material (from Williams and Butcher 2006).

The civil engineering profession can maintain a critical role in archaeological site exploration and preservation. In fact, civil engineers can be considered as essential participants in both reactive and proactive roles. First, archaeological sites are often discovered unexpectedly as part of construction and development activities, and the engineers inherit the responsibility for the fate of these sites (Salvadori 1976; Tsirk 1979). In these cases, the engineers assume a reactive role as first finders. Although there are regulations in most countries to protect archaeological material which is found on a construction site, the responsibility of preservation falls with the engineer which must be aware of such protections. Second, there are numerous other field sites that archaeologists work to explore, research and preserve. Each archaeological site is unique and requires proper planning and operations. Civil engineers can serve in a proactive role in the exploration and preservation process, working with archaeological teams to provide

engineering expertise, knowledge and application of appropriate technologies. In both cases, the impact of interactions between the two parties can be elevated through improved understanding of archaeological needs, with the goal of establishing more routine and productive collaborations.

### 2.1.1 Types of Archaeological Sites

It is important to understand that not archaeological sites are alike. Although there are many ways to classify archaeological sites (e.g. by size, by geographical location, by date) it is convenient to classify archaeological sites by their content. Customarily, the nature of the archaeological material present will dictate the preservation goals of the site. The role of engineering is to provide the knowledge and methods necessary to achieve those conservation goals. Sites may be loosely classified as any of the following:

**a.) Artifact sites:** These contain only artifacts that are usually buried at shallow depths, and there are no structures or vestiges of them remaining that are recognizable. Many pre-historical sites in America are artifact sites, and once these are fully excavated there is no need for further work to be done on the site or for preservation to happen.

**b.) Structural sites:** These contain structures, which can be still standing or in a structurally failed state, such as houses or other larger buildings. These types of structures are often referred as features in archaeological literature. These structures represent civil works from years past, and if excavation is needed challenges may be present as the structures might need structural stabilization or rehabilitation. If the structures are not subject to a preservation process, they may deteriorate by being exposed to the weather.

**c.) Mixed sites:** Some sites may present both characteristics. This may stem from being very large in size and these sites may have structures at the site's core and artifact sites surrounding. Another reason is if the site spans multiple time periods, or had a special significance (such as the remains of a religious temple which may be expected to have large quantities of artifacts nearby). These may have a structure in a focal point and have scattered artifact loci nearby.

Each different site will propose different challenges and different goals. In some cases, an important structural site may need to be excavated, stabilized and made ready for public visits while artifact sites are commonly abandoned after the excavation has finished.

Commonly, archaeological material is at depths that would be considered shallow by geotechnical engineering standards, up to 3 meters. Structural features are usually found at a larger depth than artifacts. However, the depth of the archaeological layer may vary with the age of the site and the use of the land in the past.

### **2.1.2 Archaeological Site Excavation Process**

The excavation method of a site will usually follow a plan that is formulated based on preliminary data obtained from site exploration. During excavation, archaeologists normally dig at shallow depths, up to about 5 meters. Artifact excavations are often limited to 2 or 3 meters deep with a plan area ranging from 1 square meter to as large as 10 square meters. Deeper digs might be warranted if the rate of sediment deposition is high in that area, causing archaeological material to be buried deeper. Excavations for structural remains are necessarily larger in plan area and may be even deeper.

The two major concerns with excavation are the cut stability and water infiltration. If the cut is not stable, there is a risk to researchers operating inside the excavated ground. Large soil movements can jeopardize the excavation and cause damage to the archaeological material. Even small soil movements can be damaging to more fragile remains. Water infiltration must be mitigated to reduce difficulties in the digging process and avoid damage to the archaeological material.

There are two basic excavation methods, pits and trenches. Small pits, less than a meter by a meter, are more commonly used in artifact sites. Larger pits are used to fully expose a buried structure, and the size of these pits is dictated by the size of the structure. In both cases, work is performed from the surface if depth allows, or from inside the pit if the material is too deep. Pits may be enlarged, wider or deeper, to accommodate archaeological studies. Small pits are manually excavated, although the use of machinery is not uncommon, especially for deeper pits. Larger pits are usually excavated using a combination of machinery and manual digging. The bulk removal of soil is completed with excavators, while the soil closest to the archaeological layer is removed by hand.

Trenches are more suited for structural sites, and trenches are often oriented at 45 degrees in plan view, as shown in Figure 2.3. Trenches are usually around a meter wide with vertical cut walls (enough space for a person to work) and less than 3 meters deep. They can be dug manually for small scale excavations, or if the terrain is too rough or sensitive to allow a mechanical excavator. Care should be taken to minimize soil movement of the trench walls. Most trench depths are shallow enough to remain stable. However, trenching in soft soil conditions should be engineered, especially if the trench is expected to be deeper than usual.

Figure 2.3 shows possible excavation plans for a site. In part a), we can see a possible density map that is produced using shallow exploration methods (such as shovel testing) at a site. Once the spots that have archaeological material are identified, pits may be dug at those places as shown in b). Part c) shows a possible trench layout at an archaeological site. Those trenches may be enlarged to accommodate material that is found while excavating trenches, as can be seen in d).

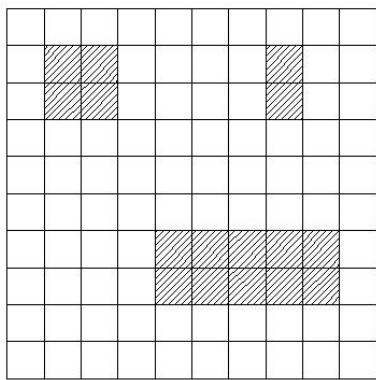

a) Grid map with results from preliminary testing

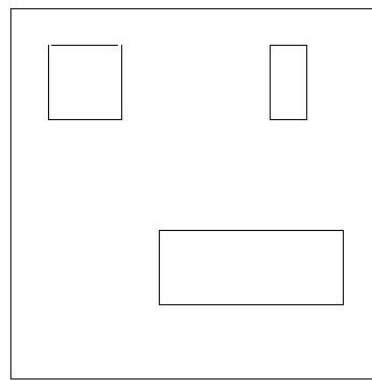

b) Pit layout for the site seen in a)

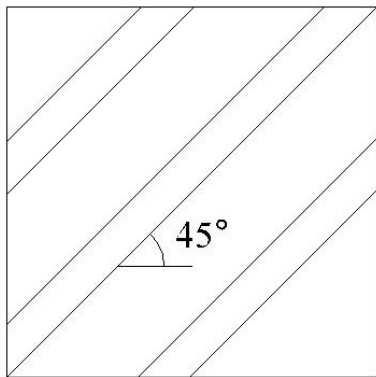

c) Trench layout for a site

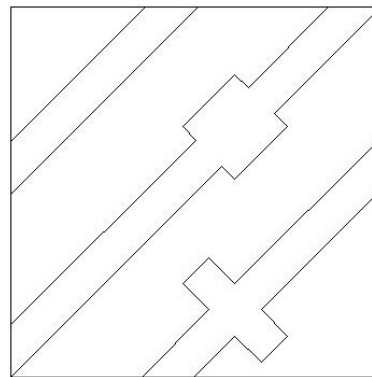

d) Enlarged trenches to accommodate finds

Figure 2.3 Different possible layouts for excavations

### **2.1.3 Archaeological Site Management: Backfilling, displaying, and reburial**

Although excavation of an archaeological site may take years, it eventually reaches its endpoint. At the end of excavation, a decision must be made regarding the future of the archaeological site. There are two main factors which influence the post-excitation life of an archaeological site: 1.) whether any archaeological material is left, and 2.) what the post excavation use of the land is.

The existence of any archaeological material at the site will ensure the necessity of a conservation program. The existence of archaeological material post excavation will primarily depend on the type of site; while it is common to remove artifacts from a site for study, the movement of features is possible yet rare. Archaeological sites which are left devoid of material will commonly lose their classification as an archaeological site, and are not commonly subject to any cultural protection. If the site will not have post-excitation construction, it is common practice that the open excavation be filled with the removed soil (as a safety precaution), without any design process. This practice will be referred to as “backfilling”. Once all open excavations have been filled, no further actions are taken on the site in an archaeological context. If the site will be used post-excitation, the constraints of the following project should dictate whether the excavations will be left open or will be backfilled.

However, archaeological material may be left at the site. This material could be artifacts, features, or a mixture of both. In this case, the conservation of the archaeological material left must be taken into account. In-situ conservation of the archaeological remains may be accompanied by total or partial display of the archaeological material left. Display of the

archaeological material will in most cases preclude non-archaeologically related construction on the site, although there have been cases in which both activities have taken place at one site (e.g. The Rose Theatre).

Although there are a range of in-situ conservation options, reburial has quickly risen as a preferred alternative. Reburial can be used in a site regardless of the nature of the material, and can accommodate many types of land usage. The reburial system can be placed over a site totally or partially. Site reburial has been practiced in the archaeological world for almost twenty five years, and is adequate for a vast array of sites. Many of the countries highlighted in Figure 2.1 have implemented reburial projects, either for preservation of sites in urban areas or for preservation of archaeological material post excavation.

A designed ground cover that incorporates reinforcing elements such as geotextiles and is designed to protect a site from the potential damaging factors in the area is a practical solution which both protects the archaeological material and allows for construction at the site. By using a reburial system to protect urban archaeological sites, we also reduce the problem of overcrowding in urban environments by allowing a site to serve dual purposes.

## **2.2 Legal framework**

Legislation protecting archaeological sites is mostly relatively recent. As archaeology developed as a discipline in the late 19<sup>th</sup> century, the legal framework to support it was not put into place until the second half of the 20<sup>th</sup> century in many places. Although international organizations, such as UNESCO, have worked to protect internationally relevant archaeological sites, the protection afforded to the majority of a region's archaeological site is highly variable, depending on local laws. Currently, most countries

have provisions protecting archaeological sites on public-owned land. However, many countries do not extend the same protection to sites found on private land.

### **2.2.1 Development of Policies in the U.S.**

In the 1970s, there was growing concern within the civil engineering community that new construction was adversely impacting archaeological sites, to the point where such valuable cultural resources were being depleted at alarming rates. In 1974, Salvadori (1976) was appointed by the ASCE Task Committee on Social and Environmental Concerns to investigate and report on the preservation of archeological sites in the United States. According to Salvadori (1976), more than half of known archaeological sites in the eastern United States were destroyed during construction related activities, and in some urban parts of the western United States (e.g., Los Angeles and San Francisco), the rate of destruction exceeded 95%. The rate of archaeological site conservation was low for three reasons: (1) inadequate federal legislation to protect archaeological sites; (2) lack of information about archaeological site conservation within the engineering and construction communities; and (3) minimal collaboration between archaeologists, engineers, and contractors. In addition, a probable fourth reason is the concern that unplanned archaeological excavation could lead to scheduling setbacks and increased project costs. However, archaeological assessments can often be conducted quickly to avoid lengthy construction work stoppages. Salvadori (1976) indicated that a few hours can be sufficient to determine the relative importance of a site, and a few days can be sufficient to complete a satisfactory study of a site.



Even though federal funds were available for salvage under the Federal-Aid Highway Act of 1956, there were limited case studies of successful collaboration between archaeologists and engineers (Salvadori and Cortes-Comerer 1977). The National Historic Preservation Act of 1966, however, led to the effort by ASCE to create a partnership between engineers and archaeologists (Hinze and Antal 1991). Salvadori (1976) argued that collaboration should be expected, given that the engineer is responsible for the discovery (and, oftentimes, the destruction) of a large number of archaeological sites that are unearthed during construction activities. It is recognized that a potential conflict of interest arises, given that work stoppage for archaeological preservation efforts can contribute to increases in construction time and cost. However, Salvadori (1976) found that the issue stemmed more from a lack of knowledge, rather than a lack of interest from engineers.

Based upon recommendations from Salvadori (1976), ASCE set up a Task Committee on the Preservation of Archaeological and Paleontological Sites, which was later integrated with the Task Committee on Social and Environmental Concerns within the Construction Division. One of the main functions of this committee was to disseminate information about how to deal with archaeological sites. ASCE passed a resolution that engineers should actively participate in the conservation of archaeological sites. The resolution was widely publicized at the time and appeared in an article for Civil Engineering magazine (Salvadori and Cortes-Comerer 1977):

*“WHEREAS, the American Society of Civil Engineers has established and supports a Committee on Social and Environmental Concerns in Construction as a technical committee under its Construction Division, and*

*WHEREAS, this Committee has personally studied for a period of two years the problems of the destruction of archaeological and paleontological sites due to construction in the United States, and*

*WHEREAS, this committee is deeply concerned about the irreparable damage to and unnecessary destruction of these remains of our precious heritage,*

*BE IT RESOLVED that the Board of Direction of the American Society of Civil Engineers invites all engineers responsible for construction projects to pledge their active participation in the preservation or salvaging of archaeological and paleontological sites and requests all members of this Society to support such activity.”*

Shortly thereafter, Tsirk (1979) advocated for a culture of cooperation between civil engineers and archaeologists to be developed for effective protection of archaeological sites. To this end, it was recommended that civil engineers:

1. Find a well-qualified professional archaeologist;
2. Involve an archaeologist in the planning stages of a project, or as early as possible;  
and
3. Seek advice and recommendations from appropriate organizations at various stages of project planning and development.

It was recognized that not all sites can be saved and preserved in-situ. However, the data contained within them can and should be acquired by performing an appropriate and thorough excavation (Tsirk 1979). This is often referred to as salvage archaeology, or conservation by record.

Table 2.1 Federal Legislation for Archaeological Site Preservation

Federal Legislation	Highlights
Antiquities Act - 1906	Establishes protection for archaeological remains on federal lands and provides for the establishment of national monuments.
Historic Sites Act - 1935	Tasks the Secretary of the Interior to conduct a national survey, using available documents and field investigations, to identify and inventory historical sites and to disseminate information about national monuments on federal and non-federal lands.
Reservoir Salvage Act - 1960	Protects historic data impacted during the construction of dams using site excavation and documentation (aka, conservation by record).
Natural Historic Preservation Act (NHPA) – 1966, amended in 1980 and 1992	Asks states to conduct surveys of significant sites and authorizes disbursement of grants to encourage state and private conservation efforts.
National Environmental Policy Act - 1969	Includes archaeological resources (e.g. sites) in the environmental impact considerations for federally funded or licensed projects.
Executive Order 11593 - 1971	Requires federal agencies to make inventories of historical sites in lands under their control and evaluate adverse effects of human activities on those sites.
Archaeological and Historic Preservation Act (AHPA) – 1974	Allows expenses for excavation and recording of archaeological sites that might be affected during “alteration of terrain” in federal, federal licensed and federal funded projects.
American Indian Religious Freedom Act - 1978	Provides for federal agencies to facilitate Native Americans’ access to sacred lands and cultural items on, or buried within, those lands.
Archaeological Resources Protection Act - 1979	Requires permits for excavation or removal of archaeological resources from federal or Indian lands.
Native American Graves Protection and Repatriation Act - 1990	Provides for the repatriation of Native American cultural items from federal agencies or federally funded agencies.

There is federal legislation to support the preservation of archaeological sites, as shown in Table 2.1. It is important to note that these legislative acts only cover federal lands, federally licensed projects or federally funded projects. Salvadori (1976) and Tsirk (1979) advocated that engineers be aware of, and abide by, pertinent legislation relating to

conservation to preclude loss of archaeological material, and even in cases where protection is not legislated, that engineers collaborate with archaeologists to consider options for preservation.

Table 2.1 lists the relevant legislation pertaining to construction sites and highlights the critical components of each act, including those acts that have passed since the cornerstone publication by Salvadori (1976).

Note that most of the federal acts offer protection of historical sites, which encompasses all sites with historical significance, including archaeological sites. Federal regulations are cumulative and work in conjunction with state and county laws or regulations (Tsirk 1979). However, if no state or local laws are present, there are no legal obligations to protect archaeological resources unless federal funds are being used in the project.

Monetary and scheduling restrictions should be taken into account when preparing to engage in archaeological research at a construction site. The decision whether to engage in field work is made by a qualified archaeologist after evaluating the site and its importance. If significant remains are found or are believed to be present at the site, excavation may be necessary. In most cases, however, a field evaluation is sufficient and allows for the continuation of construction activities with minimal delays. In cases where excavation is required, compensation from the government may be available (such as in the case of The Rose Theater in London, where the Secretary of State for the Environment contributed £1 million in exchange for a 28 day delay). Many government agencies include provisions in their contracts to accommodate for archaeological findings. Hinze and Antal (1991) analyzed the provisions for contracts by governmental organizations to determine the

consequences of encountering an archaeological site during construction. In that study, it was found that provisions for surveying a construction area were established within all state Departments of Transportation and in 92% of federal agencies, but only within 44% of municipal agencies. Three types of surveys were described: (1) a record search to establish the possible locations of archaeological sites in the vicinity; (2) a trial excavation (e.g. shovel tests and shallow exploration) to search for remains; and (3) a full site excavation. Field-based surveys (i.e., excavations) were almost always required. Furthermore, it was found that 70% of contracts included a stop work clause, and 21% placed additional responsibilities on the contractor to ensure preservation of archaeological findings. Hinze and Antal (1991) recommended that these provisions be required in all contracts, and that the contractor collaborate with the archaeological team in all operations. One of the federal agencies in particular, the U.S. Army Corps of Engineers, has been an active proponent of in-situ conservation (Mathewson 1989; New South Associates 2011; Nickens 1991b) and has promoted more collaboration between archaeologists and engineers.

### **2.2.2 Development of Policies in the U.K.**

In contrast to the U.S., archaeological sites in the United Kingdom are older and more complex because successive periods of occupancy often give rise to layers of archaeological material from different eras. There, older sites often have both structural remains and artifact troves; whereas in the U.S., most pre-Colombian sites are limited to artifacts. Collaborative efforts towards in-situ preservation in the UK were sparked in the 1990s from the creation of two Planning Policy Guidances (PPGs), PPG 15: Planning and the Historic Environment (Department for Communities and Local Government 1994) and

PPG 16: Archaeology and Planning (Department for Communities and Local Government 1990). These two PPGs were published to mitigate destruction of archaeological material due to construction activities on public and private sites, regardless of whether public monies are involved. These new policies called for preconstruction site investigation (through document research or field assessment) to avoid damaging irreplaceable archaeological material. If remains were found in the preconstruction assessment, then preservation was mandatory, either in-situ or through recorded documentation (aka salvage archaeology). Tilly (1998) makes clear that the cases he presents are work done in the wake of approval and publication of the PPG 16, which serves as an indicator of the importance and impact this guideline has had on archaeological site preservation in England.

After the release of PPGs 15 and 16, a great amount of archaeological work was undertaken in sites across the UK. PPG16 called for every construction site to be evaluated for its archaeological potential, this being determined by either remote sensing technologies such as ground penetrating radar (GPR), soil resistivity or other geophysical methods, trial trenching, or both if needed. Williams and Corfield (2002) state that PPG 16 “*positively encouraged the preservation of nationally important archaeological remains in-situ*” although certain policies may have contributed to the damage of remains (Nixon, 1998). Tilly (1998) for example, discusses case studies of five archaeological sites that were threatened by imminent construction but preserved as a result of PPG 16. In all cases, archaeologists were allowed to make a preliminary evaluation of each site and subsequently provide the project engineers with information to develop a mitigation plan that would minimize archaeological damage without unnecessary excess costs. In two cases, archaeological remains were partially excavated and construction plans were altered

to minimize ground disturbance to the in-situ remains. In a third case, an ancient burial ground was discovered at the site of a new housing complex. The resolution was to construct a post-tensioned concrete slab above the site for its protection and preservation. In a fourth case, a change in pile positioning for a commercial structure was recommended to avoid damage to archaeological remains, but it was found to be cost-prohibitive.

There were criticisms levied against PPGs 15 and 16. According to Palmer (2005), the guidance documents created a system that focused on site development and lacked sufficient focus on increasing archaeological knowledge. Most notably, the substantial influx of field sites required archaeologists to undertake new work without a research framework. In fact, the main criticism was that it substantially increased the work burden of archaeologists without adequate resources (i.e., archaeological staff and essential equipment) in a compressed timeframe, since the archaeological work had to be completed quickly to allow resumption of construction activities. Fragmentation of work was essentially encouraged, since the archaeological team members were often required to conduct work outside of their fields of specialization (Palmer 2005). As a result, some of the conservation work was not performed to acceptable standards and was insufficiently documented and processed. Thus the archaeological data were sometimes inadequate for publication and did not necessarily contribute to the archaeological record.

Both PPGs were superseded in 2010 by Planning Policy Statement (PPS) 5 (Department for Communities and Local Government 2010), which consolidated the policies from both documents and made efforts to improve working relationships between the archaeological and construction communities. While the Department for Communities and Local Government claimed that *“the planning policy for the historic environment has been*

*strengthened*” (CLG press release 23.03.10), English Heritage claimed on their website that PPS 5 “*maintains the same level of protection to the historic environment as PPGs 15 and 16.*” With the publication of PPS 5, there was enhanced flexibility in designating sites for protection, thereby increasing the number of eligible sites. PPS 5 maintained the same level of protection for scheduled monuments, listed buildings and conservation areas, but it expanded the presumption of conservation to include World Heritage Sites, registered parks, historic battlefields, protected shipwrecks and undesignated heritage assets. Whereas PPGs 15 and 16 protected only the material remains within site locations, PPS 5 extended the conservation to cover the entire site. PPS 5 was itself superseded in March 2012 by the National Planning Policy Framework (NPPF), which combines all of the existing PPGs and PPSs (which regulate a myriad of different topics, not just archaeological remains) into one cohesive document. The revised documents address some of the issues regarding time and resources for proper archaeological site conservation. The NPPF is in the process of being gradually implemented over a one-year period, and so its impacts are as yet undetermined.

### **2.3 Reburial literature review**

The first scholarly articles about reburial were published in the 1980s, but the practice only came into popularity in the 1990s when reburial entered the conservation vocabulary (Agnew et al. 2004). In the past few decades, there have been successful reburial projects with high visibility, like the Chaco Canyon (Ford and Demas 2004) and Aztec Ruins (Rivera et al. 2004) monuments in the southwestern U.S. and the Rose Theatre (Ashurst et al. 1989; Biddle 1989; Corfield 2004, 2012; Orrell and Gurr 1989; Wainwright 1989) in



the U.K. These projects have demonstrated that reburial is viable and, at the same time, provide valuable data to inform future reburial designs.

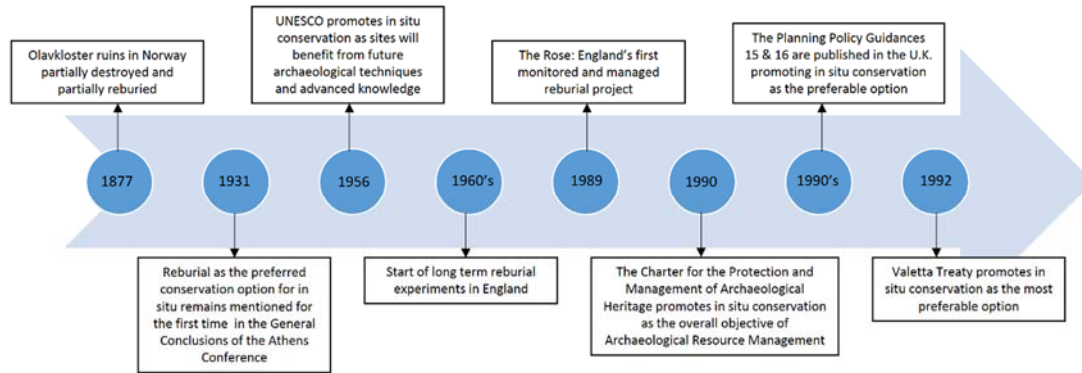

Figure 2.4 A timeline of important events in the reburial movement. Although reburial was performed prior to The Rose, projects were seldom designed and relied more on covering the area with soil

As shown in Figure 2.4, in-situ conservation has been recommended for the preservation of remains for over 80 years, and it has been used for more than a century. However, modern reburial projects (that is to say, projects which have been designed and built according to specifications rather than simple backfilling) began with the Rose Theatre reburial. This project was an important factor in the adoption of U.K. legislation to endorse in-situ conservation as the preferred option, which led to a sharp rise in the number of reburial projects undertaken.

### 2.3.1 ASCE database review

To identify the extent of published outcomes of civil engineering intersections with archaeological preservation, an online search of the ASCE publications database was conducted using search terms for “archaeology” and its derivatives. Based on a search conducted in January 2013, there were 83 publications located that met the search criteria.

Interestingly, this number of publications represents less than 0.05% of the total number of records in the database. For some perspective, a similar search of subject headings using “history” and its derivatives yielded more than 18000 publications.

Table 2.2 categorizes the search findings. Papers were classified into three categories:

**a.) Preservation**, or primary, papers focus on the preservation of archaeological remains in-situ and/or application of engineering knowledge to preserve historical structures. In terms of content, archaeological issues are of primary importance in these papers.

**b.) Construction**, or secondary, papers focus on engineering problems associated with construction, but with the added complexity of having archaeological remains present on the site. In terms of content, the construction issues are of primary importance, and the archaeological issues are circumstantial, or secondary.

**c.) Miscellaneous** papers cover relevant topics, like education or legislation, where there is reference to archaeological issues, but these issues are largely removed from the crux of the paper. In terms of content, archaeological issues are peripheral.

Figure 2.5 illustrates the chronological trend for publications related to archaeology beginning in 1986, which corresponds to the first publication year that yielded a search match. Prior to 1997, there were a limited number of papers published on archaeological issues, and none of them were focused on preservation. Since then, the total publication output associated with archaeological issues has increased, and preservation papers have also been published more regularly, although not in each and every year.

Table 2.2 Categorization of ASCE Publications related to Archaeology (1986-2012)

Categorization	Topic	Description	No. Papers
Preservation	Re-use and Replacement of Historical Structures	These papers deal with both the re-use of historical structures, such as foundations, or with the replacement of historical structures with new structures using traditional methods.	4
	Conservation and Preservation of Historical Structures	These papers deal with studies about preservation and conservation of existing archeological sites	9
	Monitoring and Evaluation of Historical Structures	These papers deal with methods to monitor and evaluate historical structures' condition	8
Construction	Just Engineering	These papers deal principally with engineering problems, and only have archaeology as a background to the work performed	26
Miscellaneous	Historical Engineering	These papers deal with how engineering has been performed historically. They research past methods and past issues with engineering.	20
	Legislation about Construction and Archaeology	These papers deal about the various legislative efforts that have dealt with construction in archaeological sites.	7
	Education	These papers deal with education in engineering	4
	Other Publications (Biographies, Discussions, Reviews)	These papers don't address any engineering or archaeological issues.	5

Starting in 2007, there was a significant rise in publications in all three categories. In fact, within the 25-year span covered in Figure 2.5, the three years with the highest output occurred in 2007, 2009 and 2010. Although it is not a scientific assessment, the recent increase in archaeological publications implies some elevated level of collective awareness within the civil engineering community to publish on these important issues.

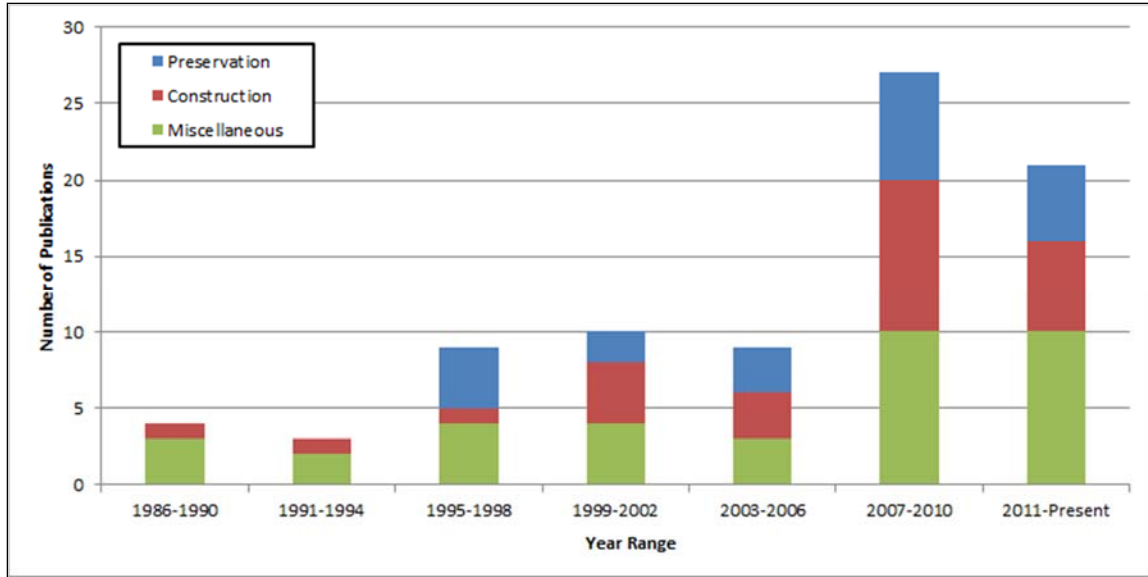

Figure 2.5 Annual archaeology related publications in ASCE journals

### 2.3.2 Archaeological preservation conferences

Cooperation between archaeologists and civil engineers has been a focal point of discussion at several landmark conferences beginning in the late 1980s. A summary of these key conferences is presented in Table 2.3. One of the earliest conferences was held in the U.S. under the sponsorship of the U.S. Army Corps of Engineers. Most of the conferences, and especially the PARIS series, have been conducted in Europe with participants primarily from European countries.

The PARIS1 conference was “*born of frustration and optimism*” ((Nixon 1998), in the introduction to Corfield, 1996). Frustration stemmed from the task of performing in-situ conservation, knowing that the full consequences of those actions would not be known until time had passed. Yet there was optimism regarding the prospect of engaging people from diverse fields to examine in-situ conservation and develop a greater understanding of the interactions between archaeological material and its environment. PARIS1 was spurred by the creation of PPG 16 and its guidelines, and it was intended to involve engineers (e.g.

Banwart, 1998; Shilston & Fletcher, 1998; Tilly, 1998; Welch & Thomas, 1998) to help meet those guidelines.

Table 2.3 Summary of Conferences with a focus on geotechnical engineering and archaeology

Name of the Conference	Date	Location	Organized by:	Number of Papers
The Engineering Geology of Ancient Works, Monuments and Historical Sites	1988	Athens, Greece	Greek National Group of IAEG	272
Interdisciplinary workshop on the physical-chemical-biological processes affecting archaeological sites	1989	College Station, Texas	US Army Corps of Engineers	15
Preventive measures during excavation and site protection: conference, Ghent, 6-8 November 1985/Mesures preventives en cours de fouilles et protection du site: conférence, Gand, 6-8 novembre 1985	1985	Ghent, Belgium	ICCROM	26
In Situ Archaeological Conservation	1986	Mexico City, Mexico	Getty Conservation Institute and Instituto Nacional de Antropología e Historia	21
Archaeological remains: In situ preservation / Vestiges archeologiques: La conservation in situ	1994	Montreal, Quebec	ICOMOS	41
Reburial of Archaeological Sites	2003	Santa Fe, New Mexico	Getty Conservation Institute, National Park Service and ICCROM	20
Preserving archaeological remains in situ (PARIS 1)	1996	London, England	Museum of London, University of Bradford	23
Preserving archaeological remains in situ? (PARIS 2)	2001	London, England	English Heritage	35
Preserving archaeological remains in situ (PARIS 3)	2006	Amsterdam, Netherlands	English Heritage, Vrije Universiteit Amsterdam	33
Preserving archaeological remains in situ (PARIS 4)	2011	Copenhagen, Denmark	Heritage Agency of Denmark, English Heritage, Viking Museum	46 (33 Oral and 13 Poster)
International Symposium on Geotechnical Engineering for the Preservation of Monuments and Historic Sites	1996	Napoli, Italy	Associazione Geotecnica Italiana	98
Second International Symposium on Geotechnical Engineering for the Preservation of Monuments and Historic Sites	2013	Napoli, Italy	Associazione Geotecnica Italiana	33

PARIS1 was followed five years later by PARIS2, which was focused on impact assessment of PARIS1 and research advancement towards in-situ conservation. Although the PARIS series has continued with conferences in 2006 and 2011, one of the roadblocks is that it has remained a primarily Northern European event (Corfield 2012). However, the PARIS series remains the foremost (and apart from “Archaeological remains: in-situ conservation”, the only) venue for discussing in-situ conservation projects. Another conference series is the International Symposium on Geotechnical Engineering for the Preservation of Monuments and Historic Sites. Although it is not a regularly scheduled conference, it aims to provide a space for discussing the different ways in which geotechnical engineering practice can be used to preserve archaeological and historical sites. Its scope is similar to The Engineering Geology of Ancient Works, Monuments and Historical Sites, in which many different topics within the intersection of geotechnical engineering and archaeology are covered. These topics include reinforcement of historical structures, ancient engineering methods, case histories of construction sites on archaeologically rich locations, and others. Because of this, in-situ conservation literature is often found in the specialized conferences.

An interdisciplinary workshop on the physical-chemical-biological processes affecting archaeological sites (Mathewson 1989a) was focused on the protection and preservation of cultural resources of lands managed under the U.S. Army Corps of Engineers. The main purpose of the workshop was to better understand the advantages and disadvantages of burial as a form of preservation and to expand its implementation. Nearly fifteen years later, the colloquium on Reburial of Archaeological Sites was held in Santa Fe, New Mexico in 2003. The colloquium was sponsored by the Geosynthetic Institute (GCI) and

the National Park Service (NPS), and it resulted in a special issue on Conservation and Management of Archaeological Sites (see Burch, 2004; Kavazanjian, 2004). One of the major outcomes was that further testing and research is required to fully understand reburial as a conservation technique (LeBlanc 2003).

### **2.3.3 Notable collaborations between archaeologists and engineers**

There have been some, albeit limited, published outcomes of collaborations between civil engineers and archaeologists (Nixon 1998; Wildesen 1982; Williams and Corfield, 2002). Collaborations have been formed from the perspective of archaeologists seeking engineers to help with their challenges (e.g., Tilly 1998) and from engineers needing to accommodate archaeologists investigating archaeological material present at a site (e.g., Brandenburg et al. 2009). For the past few decades, the archaeological community has sought closer collaboration among several disciplines like archaeology, engineering and geology (Thorne 1991a) and for this collaboration to become the norm instead of a special case (e.g. Nixon, 1998; Shilston & Fletcher, 1998). Tilly (1998) examined the challenges in relationships between archaeologists and engineers, including issues like *“having to explain the importance of what appear to be innocuous artifacts such as the discoloration of earth indicating the presence and nature of ancient settlements.”* He concluded that if there is genuine collaboration between the archaeologist and the engineer, an agreement can be reached where both parties are satisfied. To that end, this paper provides an overview of the historical and current developments in (1) archaeological preservation policies affecting construction activities; (2) forums for the dissemination and advancement of research that involves cross-disciplinary contributions from the archaeological and civil engineering communities; and (3) the transfer and utilization of

civil engineering technologies and design strategies to offer a more sustainable, engineered approach to archaeological site exploration and preservation.

Tilly (1996) discusses case studies of five archaeological sites which needed to be preserved and were threatened by imminent construction. Archaeologists were given time to make a preliminary evaluation of each site and give engineers the information needed so that a mitigation plan could be put into place to avoid damage to archaeological material and prevent unnecessary costs to the project. In two cases, archaeological remains were partially excavated and construction plans were altered to minimize ground disturbance to the in-situ remains. In a third case, an ancient burial ground was discovered at the site of a new housing complex. The resolution was to construct a post-tensioned concrete slab above the site for its protection and preservation. In another case, a change in pile positioning for a commercial structure was recommended to avoid damage to archaeological remains, but it was found to be cost-prohibitive. Tilly (1996) examines the relationship between archaeologists and engineers including problems like *“having to explain the importance of what appear to be innocuous artifacts such as the discoloration of earth indicating the presence and nature of ancient settlements.”* He concludes that if there is collaboration between the archaeologist and the engineer, an agreement can be reached where both parties are satisfied. Table 2.4 presents a summary of the case studies.

Brandenberg takes a different approach, as his is a paper detailing a new approach to obtaining ground strain values, in order to prevent damage at an archaeological site. The site, a Native American village in California’s Central Valley, was located in the path of widening the I-5 highway. Part of the site had been damaged during the original highway construction, before federal regulations mandated conservation of archaeological



materials. The site is believed to have been occupied by the North Valley Yokuts and contained an assemblage of faunal remains and manmade artifacts. Human remains have been found at the site in the past. In order to comply with legal restraints, much care was taken to ensure the protection of the site. The site was in danger due to pile driving activities, which posed a risk of both direct and indirect impact to the archaeological material. A data recovery excavation was conducted to assess the direct impact, while the ground vibrations while pile driving were used to measure indirect impact. Because artifacts are often dependent on their location to extract information, ground movement from construction was seen as a great risk to the integrity of the site. Brandenburg uses the Caltrans recommended threshold particle velocity of 2 mm/s from continuous vibration sources for fragile historic structures as a guide, although he points out that vibration induced settlement has not received as much attention as the effect if the vibration themselves on structures. Ground strains were then related to the displacement gradients, and their effect on the archaeological interpretation of artifacts in their context was evaluated. The artifacts were found at depths of 4.0 to 4.6 m, and if there was sufficient differential settlement, artifacts from different historical periods might be shifted to the same depth, leading archaeologists to mistakenly believe they are contemporaneous. Although a few centimeters of settlement were observed, the impact was deemed likely insignificant except in the immediate vicinity of the driven piles.

Brandenburg takes great care in explaining the methods and equipment he used to obtain ground strain values and displacement gradients and discusses three different methods to calculate the gradients. Although the ultimate objective is anchored in archaeology, the methods he uses are derived from engineering and the paper is ultimately an engineering

paper set against an archaeological background, though it is important to mention that the fourth author is an archaeologist.

Table 2.4 Summary of selected collaborations between archaeologists and engineers (based on Tilly 1998).

Construction Project	Archaeological significance	Engineering solution
Accommodation buildings	Site of Saxon town.	Design to minimize disturbance. Where this was no possible remains were excavated.
Factory extension	Scheduled Ancient Monument. Other archaeological remains discovered. Soil cover too thin.	The area to be disturbed was excavated and recorded.
Domestic housing	Ancient burial ground. Possible formation of 'swallow holes'. Possible damage by gardeners.	The burial site was preserved by a post-tensioned concrete slab.
Commercial development	Significant archaeological remains beneath surface.	Positions of piles to minimise damage (Project became too costly and was abandoned).
Redevelopment of office building	Significant archaeological remains about 1 m below ground. Damage caused by earlier construction.	Positions of piles to minimise damage.
Woolbeding Bridge	16 <sup>th</sup> century masonry arches strengthened to meet requirements of modern traffic.	Excavated and recorded previous levels of road surfacing and fill.

Kavazanjian (2004) studied the current and potential use of geosynthetics for archaeological preservation through site reburial. Geosynthetics have been utilized in such projects as the Rose Theatre in London, England (geomembrane coupled with a “leaky-pipe” irrigation system to maintain a water-logged environment) and the Aztec Ruins National Monument in New Mexico (geomembranes to prevent infiltration, geodrains in the engineered backfill, and a geocomposite as a root barrier). He proposed uses for other geosynthetics, such as geotextiles impregnated with biocides and herbicides to mitigate root penetration and biological activity; geosynthetic clay liners to minimize infiltration and to help control relative humidity; and geogrids, geocells and erosion control materials to stabilize the exposed surface or an archaeological backfill. According to Kavazanjian (2004), the use of geosynthetic materials in reburial designs *“have been ad hoc solutions rather than engineered applications, sometimes resulting in ineffective or less than optimal performance, unnecessary cost and, at times, even counter-productive (damaging) field performance.”*

Much of the collaboration in the UK spawned from the creation of the Planning Policy Guidance 16: Archaeology and Planning, PPG 16, which was introduced by the British government in 1990 as a guideline to avoid destruction of archaeological material due to urban development. After the release of PPG 16, a great amount of archaeological work was undertaken in sites across the UK. Tilly (1996), for example, makes it clear that the cases studies he presented are a result of PPG 16. Because of the increased volume and the tight schedule that was demanded to accommodate construction, resources became limited and some claimed that the archaeological work was not performed to adequate standards.

Furthermore, much of the data were not published because of the excess workload. However, subsequent policies have addressed these concerns.

The most recognizable case stemming from PPG 16 is the Rose Theater. While conducting excavations at 2-10 Southwark Bridge Road, the site of the Rose Theatre was found in 1989. The theatre is of special importance to the history of London since it was one of the four famous Tudor/Jacobean playhouses on the south bank (Ashurst et al. 1989). Some remains of the theatre had survived, although the site had been approved for the construction of an office building. Due to the importance of the discovery, a conservation plan which consisted of full reburial of the remains in a way that left uncovering of the them at a later date possible was drawn up, with archaeologists and developers working together to design the reburial system. The reburial system protected the remains with a geotextile and a layer of clear silica sand. An irrigation system was placed on top and then covered with another geomembrane, which was covered with a weak concrete mix. Since this fill was not designed for load bearing, the foundation elements were placed outside of the Rose Theatre footprint. The project was extensively discussed at the time (e.g. Biddle 1989; Orrell and Gurr 1989; Wainwright 1989) and is still studied today as the quintessential reburial project (Corfield 2004; Greenfield and Gurr 2004). Although it was designed to be a short term solution, the reburial system still functions well today.

#### **2.3.4 The Rose Theatre**

The creation of PPGs 15 and 16 stemmed from public outrage over the case of the Rose Theatre. The theatre is of special historical importance in England since it was one of the four famous Tudor/Jacobean playhouses located on the south bank of London (Ashurst *et*

al 1989) and the site of Shakespeare's early performances. It was the fourth public theatre to be constructed in the Elizabethan era, after The Theatre, The Curtain and the Newington Butts Theatre. It was constructed in 1587 out of timber, with a thatch roof and plaster elements in the exterior. The exact location of the theatre was lost after it was destroyed in the beginnings of the 17<sup>th</sup> century due to being rendered obsolete by The Globe, yet the existence of Rose Alley hinted at its location. Remains of the Rose Theatre were discovered in 1989 during excavation for the construction of an office building at 2-10 Southwark Bridge Road in London. Legal protection afforded to the site was limited at the time because it was a private construction site. When the remains were found, the only legal obligation was preservation by record, meaning that all of the archaeological material on site could have been destroyed. Yet the significance of the discovery, combined with pressure from the community (including protests at the site), prompted the contractors to work together with an archaeological team to create a conservation plan (with financial support from the British government). The proposed redesign called for full reburial of the remains in a manner that would allow future access for excavation. It was recommended to suspend the office building on top of the site via a pre-stressed concrete slab, which would span the remains and be supported on piles placed outside the footprint of the Rose Theatre.

Figures 2.6 (Wainwright 1989) and 2.7 (Biddle 1989) show schematics of the Rose Theatre site, which identifies the original and redesigned construction plans along with the areas of damage due to prior construction at that location. A reburial system protects the remains with a geotextile and a layer of clear silica sand. An irrigation system was placed on top of the sand and covered with another geomembrane, which was then covered with a weak

concrete mix. Figure 2.8 (Ashurst et al. 1989) shows a schematic of the finished reburial system. Since this fill was not designed for load bearing, the foundation elements were placed outside of the Rose Theatre footprint. The project was extensively discussed at the time (e.g. Biddle, 1989; Chippindale, 1989; Orrell & Gurr, 1989; Wainwright, 1989) and continues to be studied as the quintessential reburial project (Corfield 2004; Greenfield and Gurr 2004). Figure 2.9 shows the current state of the site, with the office building in use and a small entrance leading to the basement where regular performances are scheduled.

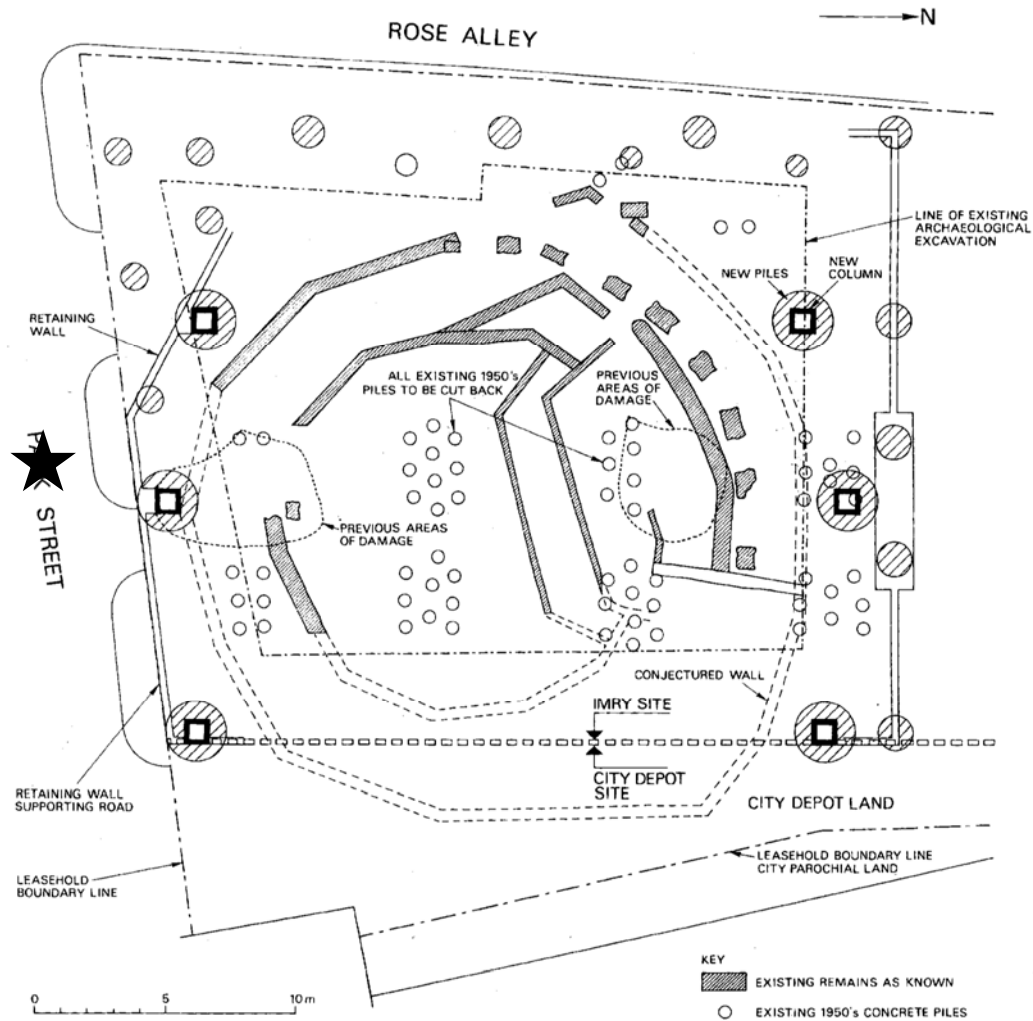

Figure 2.6 Plan of the Rose Theatre site. The approximate viewpoint of Figure 2.9 is indicated by the star on the drawing (from Wainwright 1989).

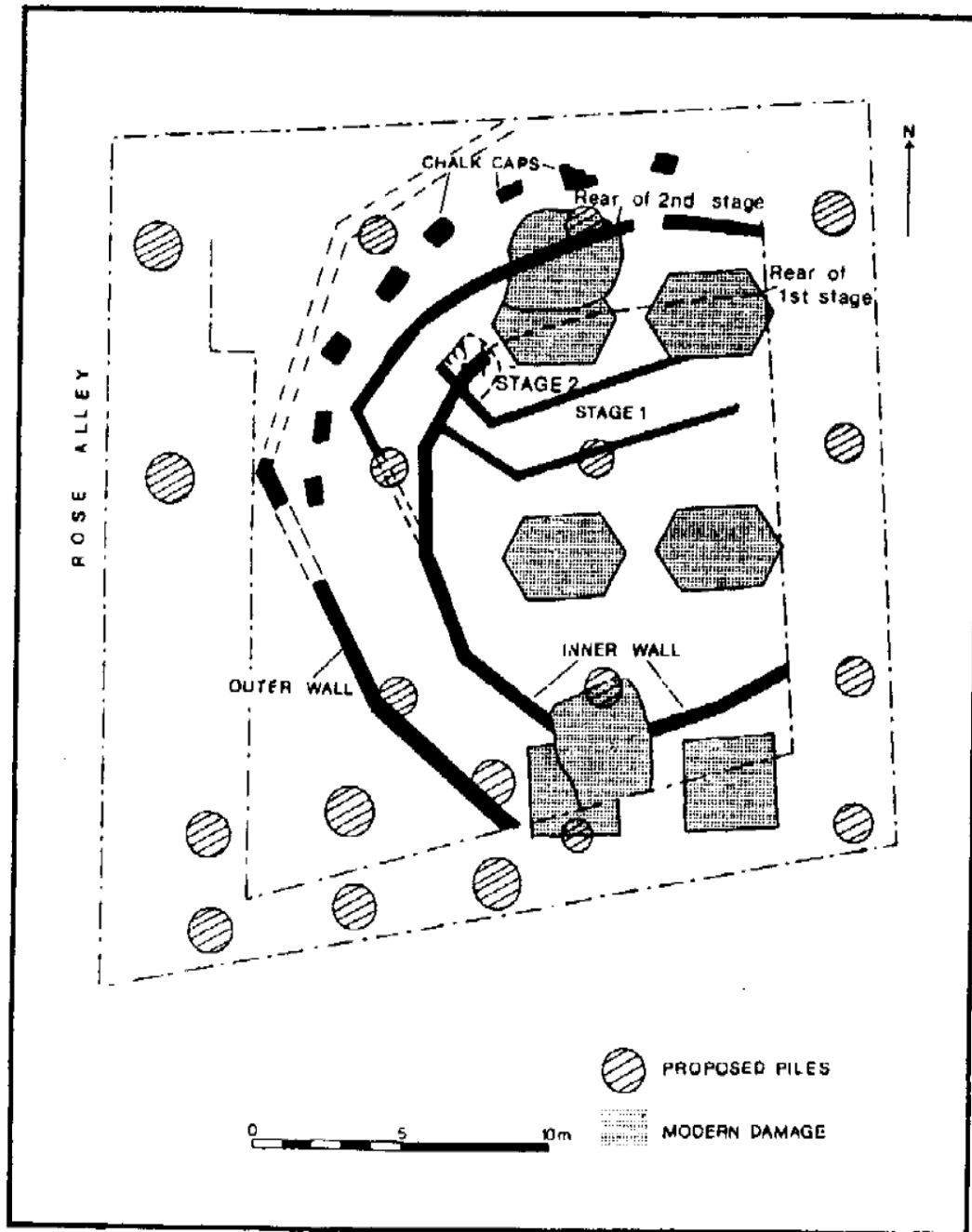

Figure 2.7 Plan of the Rose Theatre. This drawing shows the plies as originally proposed and the extent of modern damage (from Bidden 1989).

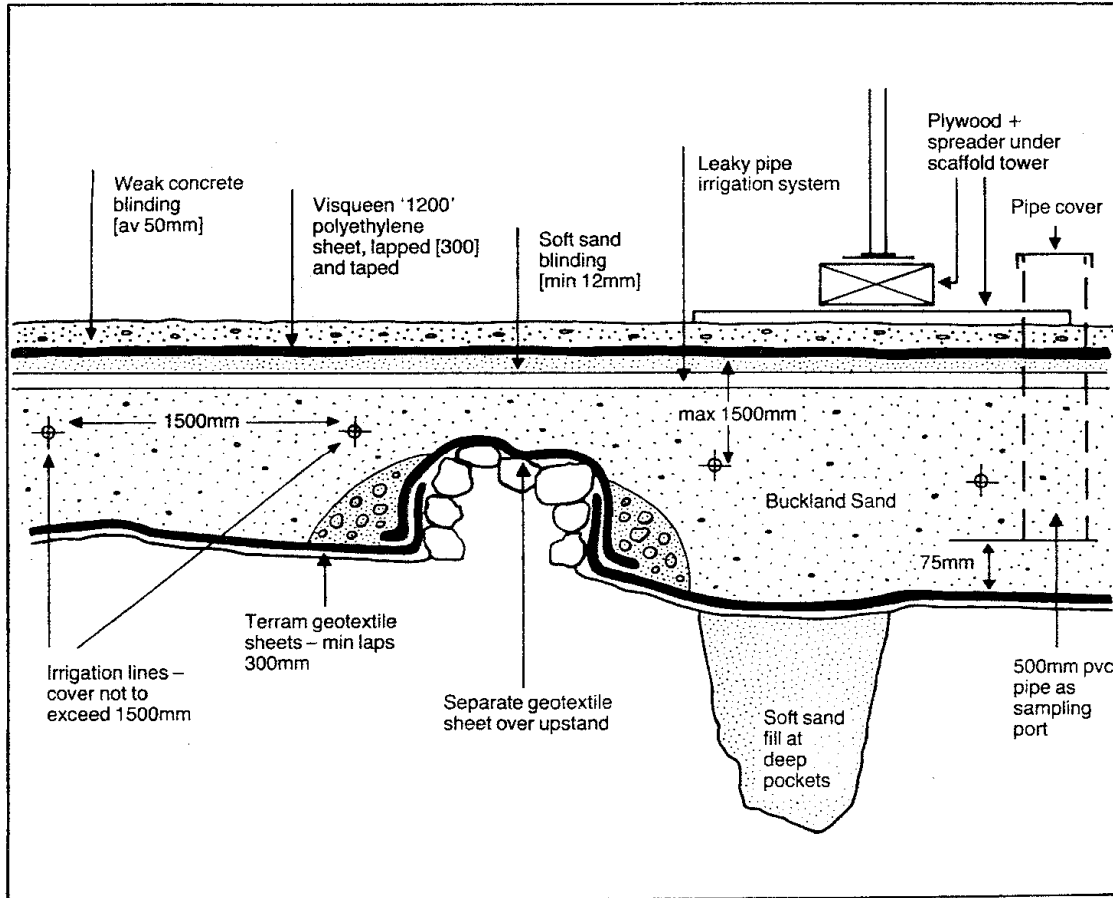

Figure 2.8 This schematic shows the reburial system originally installed at the Rose Theatre (from Ashurst et al. 1989).





Figure 2.9 Picture of the Rose Theatre building as it stands now (Picture taken in June 2012). The door on the bottom right hand leads to the basement where the theatre remains are preserved.

The future of the site was further obfuscated because of financial complications regarding the investors in the proposed new building. Money from government pensions had been used to finance the building, which added pressure for the construction to continue as planned. There were competing proposals for the design of the building basement and foundation, shown in Figure 2.10. A design commissioned by the Theatre Trust replaced the proposed piles which ran through the footprint of the theatre were by 6 larger piles at the edge of the site. The new foundation design included a large basement hall where the Rose could be displayed. The developer's plan placed the piles closer to the Theatre remains and had a lower ceiling which afforded more space to let in the building. It also required the removal of piles placed in 1951 for an earlier project which further disturbed the site. Concerns were raised that the new piles would damage the site, but the developer chose to continue with their plan. Archaeological excavations were restricted to the places where piles were to be located, instead of following standard excavation procedures. There were fears that the piles were too closely placed, and they were supported when one of the original 1587 foundations of the Rose were found in a pile pit. The foundation was recorded and removed from the site, and the pile was driven in the same location. The archaeological remains themselves were reburied, following a cover system designed to preserve the material underneath. The building owners agreed to leave the basement as a space for monitoring, visiting and other matters related to the conservation of the Rose Theatre, and in recent years the Rose has been used to mount theatrical productions.

The reburial system at the Rose theatre was specially designed to provide an answer for the site's characteristics. Because the remains were wooden, it was paramount to keep the

archaeological material saturated. A protective cover was also required to shield the remains from construction related damage.

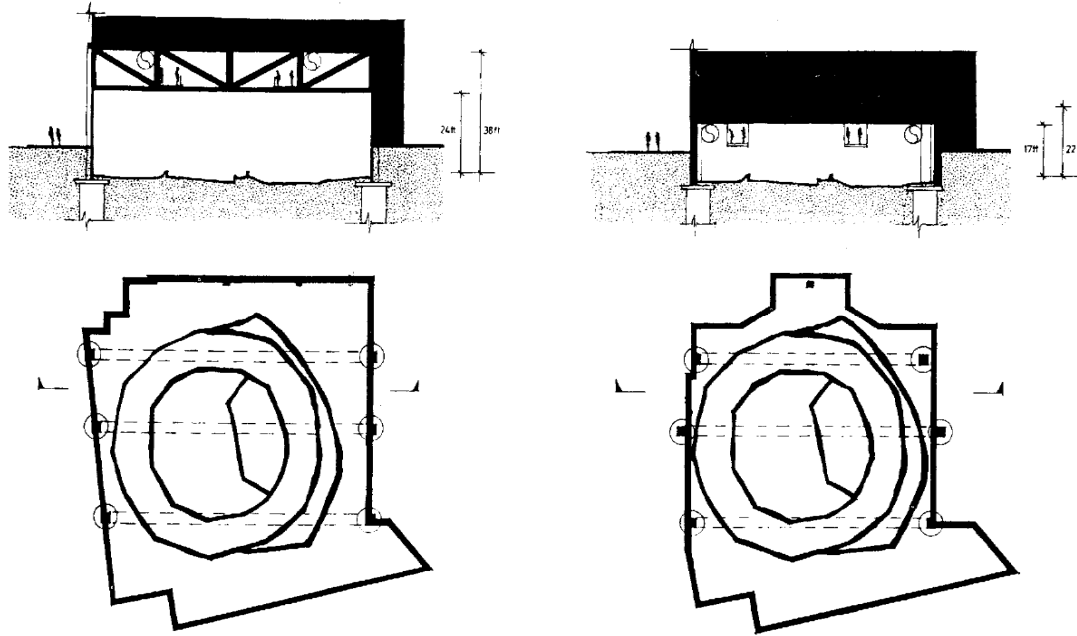

Figure 2.10 The leftmost figures illustrate the Theatre Trust scheme, and the rightmost figures show the developer's scheme, which was put into place (from Biddle 1989).

The reburial cover itself was a composite solution. The archaeological material was compacted by saturation and protected by a layer of Visqueen, a commercially available polyethylene sheeting product. A layer of iron and salt free Buckland sand 300 mm thick was placed on top of the Visqueen and also compacted by saturation. A “leaky pipe” irrigation system, consisting of placing perforated pipes 1500 mm apart was installed and covered by 12 mm of Buckland sand. The Buckland sand was itself overlaid with another layer of Visqueen, and the whole system was capped by a layer of weak mortar. The relatively complex cover system was complicated by the low headroom available and the tight time frame in which the project had to be accomplished. The excavation of the site and the implementation of the reburial cover all had to be performed during a break in

construction for the overlying building. The leaky pipe system was designed to ensure full saturation of archaeological remains, while the weak mortar provided a stiff layer to protect the Rose from construction related damage. It was deemed unnecessary to further compact the sand since this layer wasn't load bearing due to the design approved by the developer. A foundation was set up shortly to gather moneys in order to be able to buy back the property, since it was assumed that the project would be only a temporary solution (Ashurst et al. 1989). However, it was discovered by continuing monitoring that the site had suffered no damage and thus the reburial project that was designed to be a short term solution was kept in place for longer than anticipated. Although it was designed to be a short term solution, the reburial system still functions well after more than 20 years in use. The embedded irrigation system has been able to maintain in-situ soil conditions by controlling the original water content of the clay (56-83%) and peat (226%) (Corfield 2012).

This arrangement only came upon because of public pressure and from the thespian community, since the construction schedule and budget had already been taxed and because some modern damage had already occurred and the proposed piling regime would have had a very strong impact on the site (see Figure 2.7). The first excavations took place in a great hurry, and were frantic until the last day, before the site was scheduled to be turned over to the construction company for the start of backfilling, without any consideration for the survival of the site. However, in the years since its implementation, the Rose Theatre has proved to be the premier reburial project.

Although the preservation scheme put in place at the Rose has been very successful, even going beyond its intended temporary purpose, there was a decision to change it to another reburial system. One of the main reasons for switching to the new design was to provide

more headroom at the site. Furthermore, in the new reburial system a sculpted surface that replicates the real ground surface of the Rose will be placed atop the reburial system to provide visitors with a vivid image of the archaeological material preserved. Other design goals were to maintain waterlogging of the soils in the reburial system by the natural groundwater regime of the site, and that the maintenance of the reburial system be low cost. In the years since its discovery, the site of the Rose has been used as a theatrical venue, which make more comfortable conditions necessary. The updated reburial design for the Rose Theatre takes advantage of the changes in site conditions (construction has by now long ended) and allows for more headroom and for the future installation of a glass floor to see the sculpted surface. The new design provides more headroom by removing the leaky pipe irrigation system and reducing the thickness of the sand layer. The new design also incorporates a geocell material which is to be filled with iron free sand (actually re-using the material which will be removed from the previous reburial scheme). The new design is indicative of the prominence the Rose has gained (a driving reason for allowing more headroom was the development of visitor facilities) and of the progress which has been made in the battle for preservation of archaeological remains (the design is made with the idea that if the site were to be redeveloped in the future, the preservation of remains will be paramount). Although progress is still ongoing, it is expected to be implemented in the near future.

## CHAPTER 3 REBURIAL SYSTEM CLASSIFICATION

### 3.1 Reburial as a method of in-situ conservation of archaeological sites

As discussed in section 2.3.4, the case of the Rose Theatre was the primary driver behind legislation reform in the U.K. regarding archaeological site conservation, which culminated in the publication of PPGs 15 and 16. The PPGs state that if any significant archaeological material is found in a construction site (with the decision of whether a find is significant or not being left to a trained archaeologist), two alternatives are proposed. The first one, preservation by record, entails a full excavation and recording of the finds and features, which is a destructive process on its own. The second option is conservation in-situ. Conservation in-situ is to be achieved by changing the architectural design, the foundation layout, or by applying a soil cover to the site so that the development does not reach the archaeological strata. The PPGs stated that conservation in-situ was the recommended choice for significant sites, and it is then that reburial came into the spotlight. Many archaeologists have made a case for it (Demas 2004) and many reburial projects (Tilly 1998) came into being and this movement eventually reached the American coasts where archaeologists stateside started studying it in hopes of using it for their own problems.

Robert Thorne was one of the pioneers in the U.S. to do research on reburial as an in-situ conservation technique. He published some guidelines (Thorne 1991a; b), for carrying out reburial projects. Thorne (1991a) discusses the broad appeal of archaeological site conservation by stating that *“Clearly, archaeological site stabilization is an important part of several organizations’ programs and a significant preservation alternative”*. His paper is mostly focused on providing sources of information to help professionals interested in in-situ conservation find the information they need. He cites the U.S. Army Corps of Engineers, the U.S. Department of Agriculture and the National Clearinghouse for Archaeological Site Stabilization. The National Clearinghouse for Archaeological Site Stabilization is affiliated with the University of Mississippi and was the organization with which Thorne was affiliated at the time. He concludes by stating that *“Information exchange will continue to be a fundamental goal of archaeological site stabilization programs”*.

Besides Thorne, another U.S. pioneer for archaeological site reburial was Christopher Mathewson. Beyond organizing the Interdisciplinary workshop on the physical-chemical-biological processes affecting archaeological sites, Mathewson studied the decay processes of archaeological material and proposed a qualitative site decay model which has been recommended to guide the design of reburial systems (Bilsbarrow 2004; Thorne 1991a). He advocated for the reburial of archaeological sites for conservation purposes (Mathewson and Gonzalez 1988; Mathewson 1988; Mathewson et al. 1992) stating that *“it is often preferable to protect a site below and engineered cover, rather than to excavate it”* (Mathewson and Gonzalez 1988). Much like Thorne, Tilly, and others, Mathewson calls for close cooperation between the archaeologist and engineering geologist. He states that

*“the archaeologist must identify the critical components or relationships to be protected, and the engineering geologist must design the burial to produce the desired environmental conditions”*. Mathewson concludes by saying:

*“Archaeological sites represent a cultural resource that engineers must protect and preserve if they will be impacted by an engineering project. In many cases it is desirable to protect and preserve the site in place, rather than to undertake a costly archaeological excavation which only recovers part of the total site. Site protection and preservation can be achieved through burial of the site if the environmental conditions generated by the burial process act to enhance site preservation. A cooperative effort between the archaeologist and engineering geologist can successfully implement a site burial project. The archaeologist must define the characteristics of the site components to be protected and preserved, and the engineering geologist must establish the engineering specifications to produce the desired environmental conditions.”*

Reburial of archaeological sites can also be a helpful tool to protect sites which are to be excavated in the future. A widely held archaeological practice dictates that most sites only go through partial excavation, or in aphorism form “Dig only what you must”. This is done to ensure that future scholars which may have different research questions will still be able to perform excavations. Many archaeological sites will have portions left untouched to allow for future archaeologists with both different questions and better techniques, usually sites are only fully excavated when threatened by development. Reburial is a way to protect the unexcavated portions of a site from environmental damage if some portions will remain unexcavated for an undetermined period of time.



Another advantage of reburial in a controlled and designed fashion is that it can help preserve some remains that would not have been preserved if curated in a traditional fashion, due to monetary or spatial restraints. A common example of reburial being used to prevent high curating costs is with archaeological shipwrecks. Because of the high cost of preserving archaeological wood from a submerged wreck, it is often advantageous to engage in an in-situ conservation scheme. An example is the case of the Gotheburg shipwreck (Bergstrand 2002). After finding a shipwreck in the archipelago of Gotheburg, Sweden some chosen pieces were floated to the surface to be curated and displayed. The large amount of timber recovered and the special requirements to prevent destruction of it made traditional above ground conservation very hard as it was not cost effective. Since the material had been preserved remarkably well in its resting location, it was deemed that controlled reburial in a site near the original shipwreck would be the best alternative, with continued monitoring taking place to ensure the survival of the material. A reburial project took place and monitoring is carried out regularly, with the material still in good condition. In this case reburial proved to be the solution where the ethical responsibility of caring for the archaeological material was fulfilled, but at a lower cost than might have been incurred in otherwise.

### **3.2 Previous archaeological reburial experiments**

Although reburial has become a common technique for in-situ conservation of archaeological sites, most of the knowledge about it comes from case histories such as the Rose. There have been few efforts directed towards bettering our understanding of reburial by using data from rigidly designed and conducted experiments. Although much can be learned from the successes and failures of real world reburial projects, experimental

knowledge is necessary. In a reburial project the aim is to provide the environment most suited to preservation of the archaeological material, and due to this many options go untested. Laboratory tests are also less expensive and can be carried out in a shorter time frame and in greater number, thus increasing the number of options that can be investigated. Finally, while an unsuitable reburial cover will add to our knowledge if tested in a laboratory, such a cover could prove disastrous in the field signifying a loss of archaeological information and the waste of resources.

Much of the experimental reburial projects have been large scale. One of the first was carried out at the Modern Bog National Nature Reserve, near Wareham, Dorset in southern England. It is part of an archaeological experiment designed to better understand the early changes that influence the archaeological record (Lawson et al. 2000), and as such is not an experiment designed to test the benefits of archaeological site reburial. The experiment, which started in 1963, consisted of building banks and ditches of precise specifications at two sites and to excavate at regular intervals. Along with the earthworks at Wareham, kindred works were built at Overton Down, Wiltshire, also in southern England. The soils at Wareham were chose to contrast the ones at Overton Down. The soils at Wareham are acidic, podzolic and well-drained sands while Overton Down was located in an area of chalky hills which corresponds to a Typic Rendoll loamy skeletal mesic soil under the USDA soil classification system. Overton Down soils tend to be well-drained, organic-rich soils with a stable open structure and with soil pH which is alkaline or neutral (Crowther et al. 1996).

At both sites, a collection of representative artifact samples were buried under clearly marked earthen banks. The samples were to be excavated and studied at intervals originally

proposed as 2, 4, 8, 16, 32, 64 and 128 years. At Wareham, the materials used were: woolen contrast cloth (undyed warp and dyed weft), worsted gabardine (dyed woolen textile), sponges soaked in blood, unbleached linen, leather, goatskin, hemp rope, flax rope, oak wood (charred and uncharred), hazel wood (charred and uncharred), human bone, cremated animal bone, glass, metals and pieces of fired clay. Artifacts were buried either at the interface between the natural soil and the earth bank, or higher up in the bank.

Though the experiments have not ended, there is data available regarding the fate of the buried artifacts. After excavating at Wareham in 1996 (the 32 years excavation took place a year later), Lawson et al (2000) discovered that the organic material had decomposed. Although some residues of the organic materials were detected, it was necessary to use isotopic labelling. However, it is stated that due to the construction of the bank, it is reasonable to expect that aerobic microbial metabolism was supported since its construction and that the rapid decomposition of the organic materials had happened well before excavation. Non organic remains were found in good condition at the site.

An excellent example of a testing plan designed to test the benefits of archaeological site reburial can be found in Agnew, Selwitz, & Demas (2004). They detail the results of a large scale reburial experiment in Fort Selden, New Mexico which was performed in order to guide the design of a more permanent reburial system in the same place and to provide unambiguous information for archaeological reburial practices in general. The experiments were performed in pits and at ground level and used a standard artifact (a brick composed of adobe and lime with a wooden base) as well as other indicator artifacts (wood, textile, brass) for a period of 18 months.

Experiment	Depth (m)	Fill	Geotextile or clay (depth from surface)	Water	Pit experiments			
					Overall	Adobe	Lime mortar	Wood base
1	0.6	sand	none	yes	intact	eroded	sand embedded	
2	0.6	sand	none	no	intact	less eroded than No. 1	few embedded sand grains	
3	0.6	soil	none	yes	intact	edges eroded	cracked and pitted	
4	0.6	soil	none	no	intact	fused with soil	good	termite damage
5	0.6	sand	Akzo geotextile wrapping	yes	partly deteriorated	basal slumping	good, cracked	termite damage
6	0.6	sand	Akzo geotextile wrapping	no	partly deteriorated	basal slumping	good	no termite damage
7	0.6	sand	Akzo geotextile layer at 0.9m	yes	partly deteriorated	edges eroded	sand embedded	rot
8	0.6	sand	Akzo geotextile layer at 0.9m	no	intact	very good	sand embedded	extensive rot
9	1.2	sand	none	yes	intact	good	sand embedded	
10	1.2	sand	none	no	very good	good, root growth	good	termite damage
11	1.2	sand	wet bentonite covering	yes	deteriorated	artefact badly deteriorated	in wet clay	
12	1.2	sand	moist bentonite layer at 0.9m	yes	generally intact	edge erosion, cracking	sand embedded	

Experiment	Depth (m)	Fill	Geotextile or consolidant	Water	Surface experiments			
					Overall	Adobe	Lime mortar	Wood base
13 (control)	n/a	none	none	no	badly deteriorated	mostly eroded	good	n/a
14	n/a	none	Akzo geotextile wrapping	no	adobe and lime mortar faces separated	mostly eroded	good	n/a
15	n/a	sand	Akzo geotextile wrapping	no	intact	slight basal slumping	good	n/a
16	n/a	soil	Akzo geotextile wrapping	no	deteriorated	severe basal slumping	good	n/a
17	n/a	sand	Sympatex® wrapping	no	slight erosion	cracked	n/a	
19	n/a	soil	none	no	good	erosion on top	good	n/a
20	n/a	soil	Silbond® 40	no	excellent	excellent	excellent	n/a

Note: test number 18 was a surface test of herbicide and is not reported on.

Figure 3.1 (from Agnew et al., 2004). Summary of the reburial experiments at Fort Selden, New Mexico.

The native soil at the site is an alkaline and calcite rich clay. Because of the small amount of systematic research on the subject and the highly destructive potential of them, it was decided to use wet/dry cycles in some of the pits. Other variables were fill material (free draining sand which provides an aerobic environment and moisture retaining smectite clay which may provide an anaerobic environment), the use of geosynthetic materials, the use of a soil consolidant (Silibond 40) and the use of Bentonite. Instrumentation was placed to survey moisture content and oxygen levels, which could be correlated to archaeological material deterioration. A summary of the different pit configurations as well as short qualitative assessments of standard artifact conditions can be found in Figure 3.1.

The experiments, which were carried out in 1995-1996, followed a similar experiment at the site in 1988 where adobe walls were buried. The 1988 experiments guided the design of the latter experiments. In the earlier experiments, two adobe walls were built and sprayed regularly with water (88 liters per day) for the first 4 months. After that, only natural exposure to the elements was used. One of the walls was draped with a non-UV stabilized polypropylene geotextile (Mirafi 140NS) and covered with soil, while the control wall was also covered with soil, but uncovered by the geotextile. The tops of both walls were left exposed. The geotextile quickly (in 2 years' time) deteriorated when exposed to the sun, gradually thinning until disintegration, but was replaced afterwards. After excavation, it was found that the wall which had been covered with the geotextile had remained in much better condition than the control wall, which had lost 15-20 cm of height due to decay. Both of the wall sections which were buried were in better condition than the uncovered portions, but the control wall had showed more signs of deterioration. Overall, the geotextile covered wall showed evidence of superior protection, which informed the use of

geotextiles in the later environment. Because smoother fabrics have less chance of adhering to the material, a slick geotextile (Akzo 4.3, a polypropylene geotextile) was chosen.

As can be seen from Figure 3.1, drier environments were more conducive to preservation of the archaeological remains. Deeper pits were also conducive to preservation of the adobe artifacts, as greater fill depth slows down wet/dry cycles. However, in pit experiments it was found that embedding of granular soil particles on the lime mortar and adherence of soil to unwrapped artifacts were problems. In the ground experiments, it was found that the soil consolidant was effective to prevent decay due to two reasons: it prevented erosion of the soil mound, and it provided a moisture barrier.

The authors conclude with some recommendations for future soil reburial experiments: to use a standard artifact in order to provide a yardstick against which decay can be measured, and to use simple ways to measure as their instrumentation failed early in the experiment. They also conclude that geotextiles can be a great addition to provide protection to archaeological material, and that the use of a vapor permeable but liquid permeable textile (such as Gore-Tex®) should be researched.

Many reburial experiments are designed for the preservation of saturated archaeological wood. Shipwrecks and other submerged structures drive the need for alternative methods of preserving waterlogged timbers. This need stems from three reasons: first, the high cost of storage and stabilization of timbers; second, the fact that resources may not be available for traditional conservation; and third, that it may not be necessary or desirable to excavate a particular site (Gregory 1998).

There have been both large scale (Bergstrand 2002; Björdal and Nilsson 2007; Stewart et al. 1995) and smaller scale (Björdal and Nilsson 1998; Gregory 1998) experiments in archaeological wood reburial. Curci (2006) provides a review of a large number of experiments with wood reburial. The literature agrees that the principal mechanisms of degradation in marine wood are large wood borers and microbial activity. Reburial in the marine sediment at a depth larger than 50 cm, along with use of geotextiles was found to enhance preservation from these sources of damage. Burial, along with the geotextile, provided both a physical barrier to defend against the large borers and an anoxic and reducing environment which negatively impacted microbial activity. Continued monitoring of the reburial site was paramount to ensure that conditions conducive to preservation were maintained.

There has been relatively little research on the behavior of soil during reburial projects. In 1999, the Urban Regeneration and Environment (URGENT) project was funded by the National Research Council (NERC). The project's goal was to address "*perceived serious deficiency in the archaeological community's understanding of how archaeological sediments and the artifacts contained therein have and will respond to a range of loading and unloading*". The project aimed to establish a database of geotechnical parameters for construction work in sites where in-situ conservation projects were to be carried out by using a combination of field work, laboratory geotechnical testing and critical state soil mechanics modelling. The first stage of the project was geared towards gathering basic data on the loading and unloading behavior and vibration responses from soils. It was decided that London would be chosen as the subject area, because of the high rate of

development and the vast archaeological resources in the city. A good track record of in-situ preservation projects (e.g. The Rose) also influenced the decision (Sidell et al. 2004).

Soil samples (17 in total) were acquired from the greater London area and were chosen to represent the range of soils found in the city. Sands, clays, and silts were sampled and tested, while gravel samples were taken but not examined. Peat samples were planned to be taken and examined at a later date. Artifacts samples (wood, stone, bone, glass, brick, tile, pottery, metal, and prehistoric timber) were also acquired. Vibration data was acquired after monitoring vibro-compaction, drop hammer piling and continuous flight auger construction operations at sites in London.

A comprehensive test program was designed to characterize the soil samples. British Standard Institution test standards were used to determine particle size distribution, plasticity, bulk and dry density, porosity, permeability and natural moisture content. A triaxial stress-path cell with a sample diameter of 38 mm was acquired and used to determine the consolidation and monotonic compression properties of the tested samples. Figure 3.2 shows a proposed artifact testing program, where the archaeological material is placed as an inclusion in the soil sample and strain monitored in the vertical and horizontal planes. As of 2012, this testing plan had been suspended indefinitely (personal communication with Sidell). The samples were first tested in isotropic conditions, using field stress boundary conditions, and then tested under different stress conditions to model behavior under different site conditions. Vibration patterns caused by construction activities were acquired using a Magus Vibroanaliser and used to imitate stress conditions while piling using a cyclic loading cell. Due to a lack of adequate monitoring equipment, artifacts have been unable to be tested.



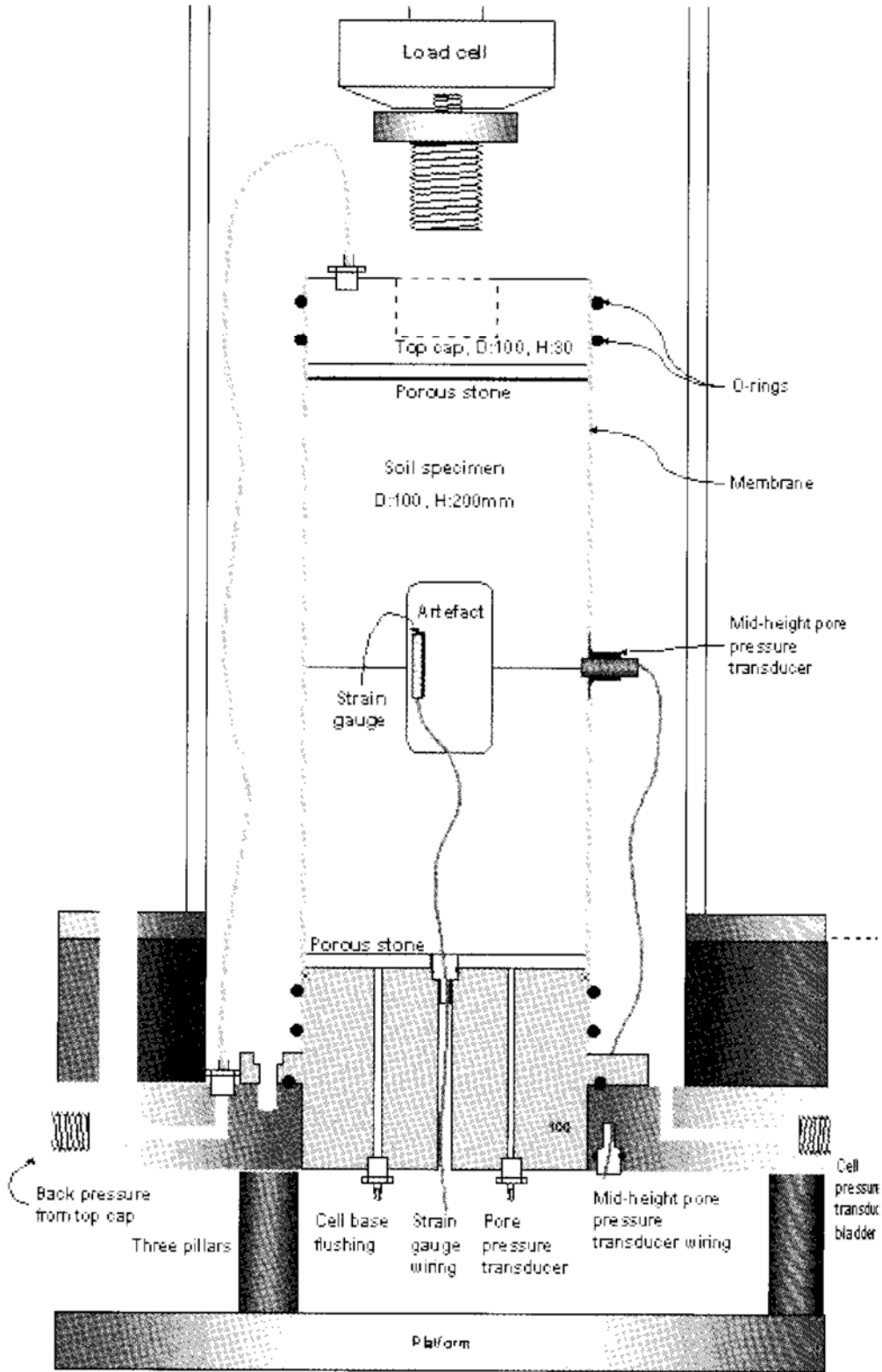

Figure 3.2 Proposed triaxial test with an archaeological inclusion (from Sidell et al. 2004).

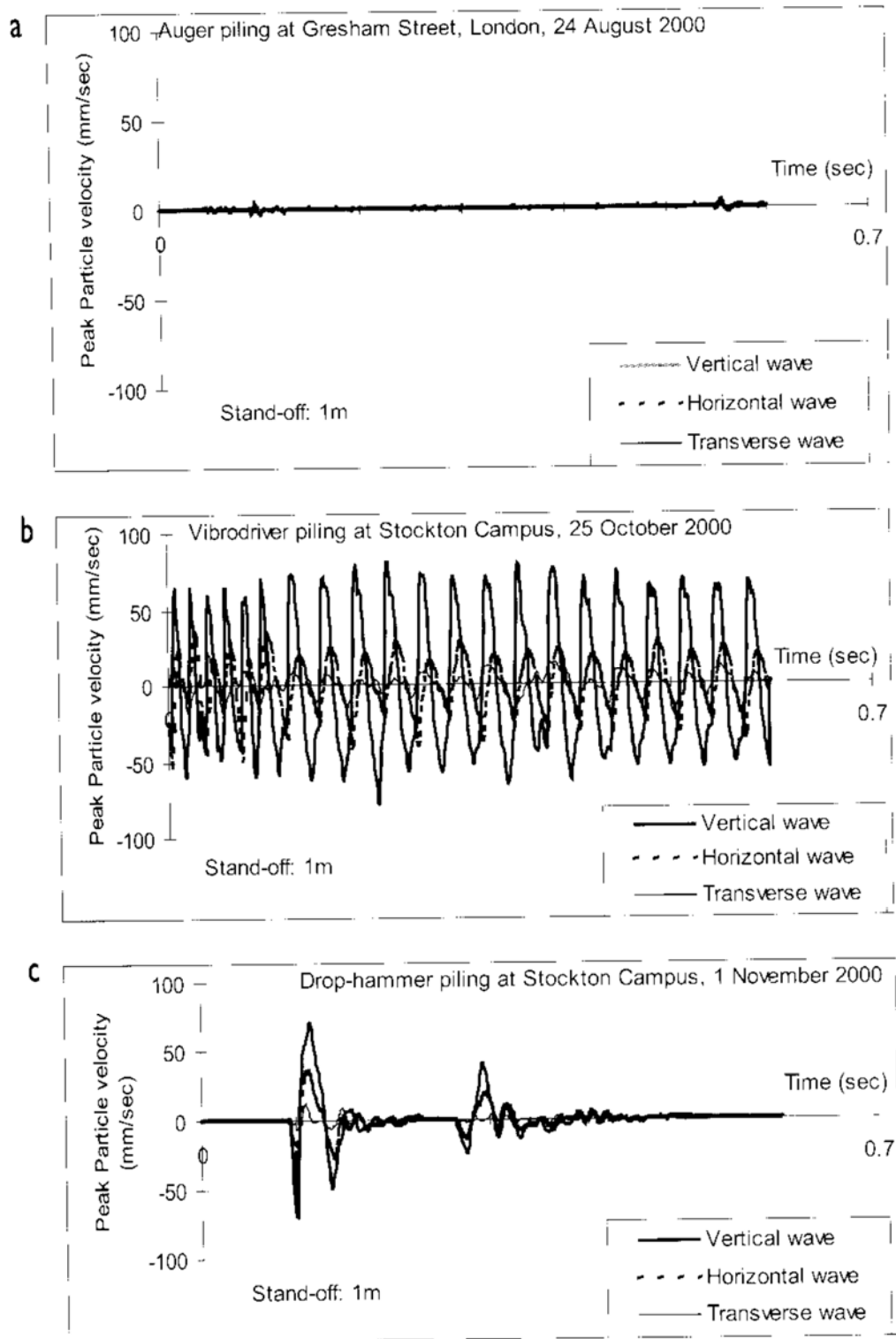

Figure 3.3 Vibrational patterns from: a.) auger piling, b.) vibro-compaction, and c.) drop-hammer piling (from Sidell et al. 2004).

The vibrational patterns acquired are shown in Figure 3.3. All of the patterns were measured 1 meter away from the source. The results show that while auger piling is relatively harmless to archaeological material (the source graphic even suggests that peak particle velocity might stay under the Caltrans recommended limit of 2 mm/sec), both drop-hammer piling and vibro-compaction have large peak particle velocities which disturb archaeological materials. In the years since, there have been publications (English Heritage 2007; Environment Agency 2006) which give guidelines to archaeologists about the impacts of piling on archaeological sites.

The early triaxial testing determined that the sand samples have a greater strength and were less compressible. A silty sand sample exhibited a continuous strain hardening behavior and resisted failure even at an axial strain of 10%. Because of this, engineering professionals considered granular material to be more suited for reburial projects, although it was thought that with granular soils the applied stresses might be transmitted to the artifacts with less stress dissipation.

### **3.2.1 Reburial Selection Process**

While no standard design process has been published, Demas (2004) has described the general decision-making process for conservation, with a focus on reburial. Figure 3.4 illustrates a four step process based on Demas (2004). The first step is preparation, which involves gathering information about the site. The second step is to assess and take stock of the site. This step includes determining the archaeological value of the site; determining the current condition of the site and the potential threats to its conservation; and studying the larger context of a potential reburial project, to include understanding what social,

political, and economic factors may affect its survival. The third step is to respond to the assessment, and make decisions for the future of the site. Some of these decisions include choosing an appropriate conservation option and developing a conservation strategy. The fourth step is monitoring and maintenance. Proper monitoring will not only ensure that the system is working as designed and protecting the archaeological remains, but it will also provide important field data that can inform research on reburial system design and performance. Unfortunately, adequate and appropriate site monitoring is often overlooked, especially in smaller projects.

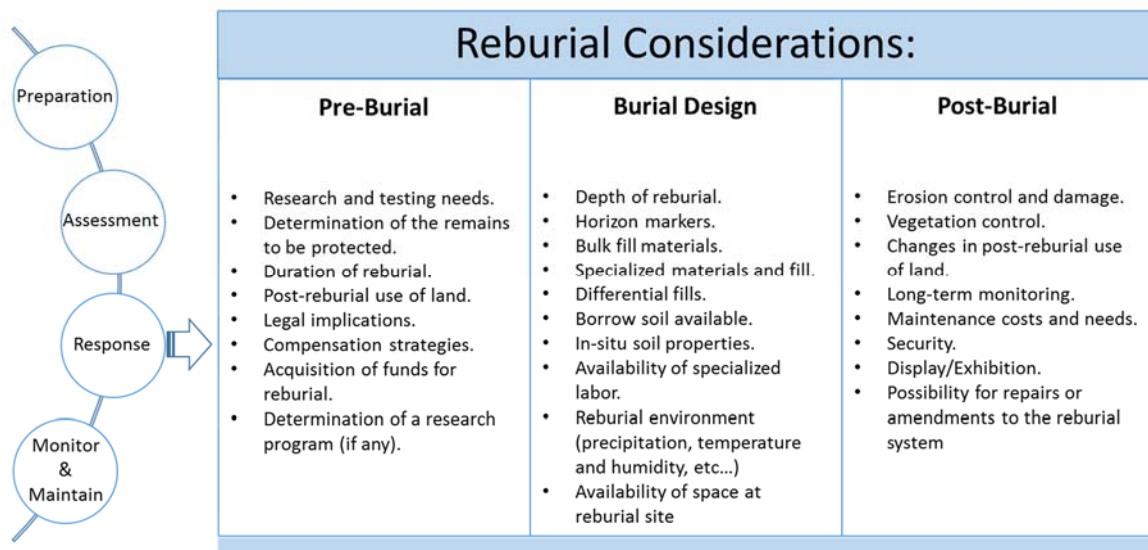

Figure 3.4 Decision making process for reburial (modified from Demas 2004)

If reburial is chosen, Demas (2004) provides a set of considerations for the stages of pre-burial, burial design, and post-burial. Pre-burial considerations are examined after the project has been approved. During this phase, important decisions about the archaeological site must be taken, including the acquisition of funds for the reburial project, the research

agenda which will be undertaken at the site, and legal or societal concerns about the project. The existence of a research agenda will significantly impact the duration and budget of the reburial project, as it will dictate the excavation process. The conservation goals and future development strategies should be determined as accurately as possible, although these might change during the life of the project. During the design of the reburial system, technical considerations must be weighed. Although certain restrictions are outside of the control of the designer (e.g. specialized labor, space available at reburial site), the design for each system can be customized to meet the demands of each project. During the post-burial phase, the considerations are focused mostly on maintaining the integrity of the reburial system through the establishment of a long term monitoring program. Monitoring of the site should focus on measurable properties (e.g., pH, redox potential, dissolved oxygen, conductivity, temperature, settlement) that can act as an indicator of changes in the reburial environment. It is important to be able to perform repairs or amendments to the reburial system if monitoring shows that it is not providing adequate protection. Lastly, future plans for the site will dictate whether provisions are required for security and/or visitor accommodations.

Two common challenges arise during the reburial system design phase. First, reburial system dimensions are dictated by the space available and the intended post-reburial use of that site. Cases where a building is to be constructed above the remains, like at the Rose Theatre, can restrict the useable vertical space. Although sufficient space to accommodate visitors is rarely needed, the space available (that is, the space above the remains but below new construction) must be sufficient to contain the reburial system and meet access requirements (for instance, to secure water samples for monitoring). Second, the selection

of materials, both natural and synthetic, for construction of the reburial system depends on availability and budget. In many cases, the cheapest material available is the one that is used (Johnsen 2009). In the Nedre Bakklandet 56 project (Johnsen 2009), for example, the geotextile that was being used at the construction site was also used for the reburial system, by default, because it was readily available.

Although pre-burial considerations and the anticipated post-burial land use are frequently discussed in the literature, the design phase considerations are often omitted or insufficiently detailed. Specifically, there is a lack of information on the construction details and system dimensions. More emphasis should be placed on design, to include expanded discussion of site subsurface conditions, fill selection processes, fill material properties, and the consideration of alternative reburial systems or alternative materials. Furthermore, there has been some limited discussion of monitoring plans and installation details for reburial projects, but often without subsequent publications that include short- and long-term performance data. The importance of making these data available is well recognized in the community, but much data remains unpublished.

### **3.2.2 Pre-burial Research**

The practice of reburial must be one that involves engineering design, and it is important for the reburial designs to be studied and tested prior to their implementation. Demas (2004) indicates that two important considerations in the pre-burial stage are to (1) identify research and testing needs and, based on those needs, (2) determine and structure a research program. There has been some published literature on research to inform the design of reburial systems, but it remains limited.

Podany et al. (1994) evaluated traditional approaches for mosaic reburial systems, consisting of different fill materials with an interface material in some cases, and performed small scale laboratory tests of common reburial materials. Although their experiments were focused on mosaic preservation and only qualitatively evaluated the effectiveness of the reburial system, it is *“part of a larger effort to study and characterize reburial strategies and the effects of those strategies upon archaeological sites.”* They found that a system consisting of a coarse soil (sand or gravel) backfill combined with a geotextile interface (separating the archaeological material from the backfill) was the optimum configuration for mosaic preservation based on the tested alternatives.

Agnew et al. (2004) states that although there is information available which *“identifies broad categories of fill type, materials and the below-ground physico-chemical and biological conditions which favor survival of archaeological artifacts”*, there has been *“relatively little systematic research and testing”* on the reburial conditions of alternating wet-dry sites. To provide guidance for long-term reburial, they conducted a full-scale 18 month trial reburial project at Fort Selden, New Mexico. Among the conclusions drawn was that a standard artifact should be designated to provide a point of comparison across reburial methods. A constructed artifact, duplicated and placed into each test pit, provided a reference for evaluating differences in degradation among the pits. To make such a comparison, however, there must be uniformity in the control variables in the test pits. They also called for more research on the reburial of wooden artifacts and the deterioration processes of geotextile materials in the context of archaeological site reburial. It should be noted that research on the degradation of geosynthetic materials is available in the engineering literature (Brand and Pang 1991; Koerner et al. 1998; Mueller et al. 2003).

Björddal and Nilsson (1998) conducted small scale laboratory reburial experiments on wood preservation, measuring the mass lost in pine stakes buried in contact with three moist but unsaturated, slightly alkaline soils (pure clay, homogenous sand, and topsoil). It was determined that soft rot is the main mechanism of degradation and either sand or clay provided a more protective environment when compared to topsoil, since the presence of organic matter can stimulate microbial activity and accelerate decay. Placing a geotextile over the stakes was found to have a significantly positive effect on preservation (i.e., reduction in mass loss). This is likely the result of the geotextile providing a barrier that prevented direct contact with the soil, which “*probably delayed infection and decay of the wood*” (Björddal and Nilsson 1998). Depth of burial is an important factor in preservation (Björddal et al. 2000), since shallow burials can allow oxygen to be sufficiently accessible to maintain a constant rate of aerobic decay in the archaeological material; whereas, deeper reburials can exclude diffusion of oxygen towards wood samples. The selection of fill with low permeability (either naturally or through compaction) can impact the depth of burial needed, with less permeable soils (e.g., clays) allowing for shallower burials.

Sidell et al. (2004) proposed an advanced experimental plan that included geotechnical laboratory tests, such as modified triaxial tests, to evaluate the performance of artifact inclusions under applied stresses. The testing plan was part of a larger project developed in response to “*a perceived serious deficiency in the archaeological community’s understanding of how archaeological sediments and the artifacts contained therein have and will respond to a range of loading and unloading scenarios.*” (Sidell et al. 2004) The project intended to combine field archaeological investigation, a laboratory geotechnical testing plan, and geotechnical modelling based on critical state soil mechanics. Vibration



data were acquired to simulate the in-situ stress conditions present during piling operations. Although the proposed test plan and modelling were never carried out (personal communication with Sidell), it offers guidance for future testing that could be implemented to support research on engineered designs of reburial systems. It is important to note that the initial phase of testing (which was in fact carried out) included extensive characterization of the soils present at the archaeological sites, which is a critical step that is often omitted during reburial projects.

### **3.3 Reburial covers**

Table 3.1 provides a list of 20 selected reburial projects completed between 1989 and 2007. Although this list is not exhaustive, it presents a representative sample of reburial projects in terms of system complexity and size of reburial. Some of these reburial systems have been identified in the literature as common practice, while others have been implemented at multiple sites. Because of the transferability of these designs, they are considered to be general use. However, most reburials are designed for site-specific conditions.

The size of reburial was divided into three categories. It is important to note that although reburial systems are usually placed over the whole area of the site, partial reburial is also possible when desired. When discussing size, it is to be understood that it refers to the plan area of the reburial system, which may be different from the plan area of the archaeological site. Small reburial projects cover an area similar to that of an average residential structure (up to 100 square meters). Medium sized reburials cover the footprint of a larger commercial building, like an office complex, retail structure, or other similarly sized

projects (up to 1000 square meters). Large reburial projects protect an entire complex of ruins and cover an area equal to or larger than a city block (up to 10000 square meters).

Table 3.1 List of reburial projects

Project	Size	Location	Date	Key Publications
<b>General Use Reburial Systems</b>				
<b>Clean Sand/ Sheffield Furnaces</b>	Variable	Sheffield, England	"Recent"	Canti and Davis 1999; Goodburn-Brown and Panter 2004; Thorne 1991
<b>UK Common Practice</b>	Variable	-	-	Goodburn-Brown and Hughes 1996
<b>US Common Practice</b>	Variable	-	-	Kavazanjian 2004
<b>Mosaic Reburial</b>	Variable	-	-	Kavazanjian 2004; Mora 1986
<b>Site Specific Reburial Systems</b>				
Guildhall Yard	Small	London, England	Winter of 1988	Goodburn-Brown and Hughes 1996
Bramcote Grove	Small	London, England	Spring of 1992	Goodburn-Brown and Hughes 1996; Johnsen 2009; Nixon 1998
Suffolk House	Small	London, England	Winter of 1994-1995	Goodburn-Brown and Hughes 1996
Burial Ground	Small	England	Prior to 1998	Tilly 1998
<b>Second Shardlow Boat</b>	Small	Derbyshire, England	1998	Williams et al. 2008
Katarina Hospital	Medium	Bergen, Norway	1986	Johnsen 2009
<b>The Rose Theatre</b>	Medium	London, England	1989	Corfield 2004; Wainwright 1989
<b>The New Rose</b>	Medium	London, England	Started In 2013	Corfield 2012
Springhead	Medium	Kent, England	Summer of 2002	Goodburn-Brown and Panter 2004
Park Lane	Medium	London, England	Prior to 2004	Goodburn-Brown and Panter 2004
Skjærvika	Medium	Hammerfest, Norway	2005	Johnsen 2009
<b>Bristolkvartalet</b>	Medium	Trondheim, Norway	2006-2007	Johnsen 2009; McLees 2008
E-6 Project	Small	Østfold, Norway	Prior to 2007	Johnsen 2009
Nedre Bakklandet 56	Medium	Trondheim, Norway	2007	Johnsen 2009
Chaco Canyon	Large	New Mexico, USA	1990	Ford et al. 2004
Aztec Ruins	Large	New Mexico, USA	1990	Silver et al. 1993

The complexity and size of the reburial system are independent of each other. Size is dictated by the area of the ruins to protect; whereas, complexity is determined by the design and performance requirements for the reburial system. For example, although both of the Rose Theatre's reburial systems and the one employed in Skjærvika are of comparable sizes the systems placed at the Rose are complex, having many different elements and different types of materials. Conversely, the remains at Skjærvika were only covered with a permeable geotextile, and then covered with turf, resulting in a simple reburial system.

Eight of the reburial systems listed in Table 3.1 (shown in boldface) were selected as representative examples of the range of reburial systems. Four of the examples are considered to be general use, and the other four represent site-specific case histories. Cross sections of these eight examples are illustrated in Figures 3.5, 3.6, and 3.7. Spatial dimensions are specified when available from the published literature.

### **3.3.1 General Use Covers**

There are three reburial systems that have been implemented at multiple archaeological sites and are considered to be general use: (1) clean sand; (2) UK common practice; and (3) US common practice. These are shown in Figure 3.5. A fourth reburial system has been proposed specifically for in-situ preservation of mosaics, but no such systems have been constructed to date. All four systems can be implemented for a range of reburial areas, from small to large, as noted in Table 3.1. These systems all include a sand layer as the soil layer closest to the archaeological material. This is to provide an immediate environment which is chemically inert, so as to prevent decay of the archaeological material. However, no guidance is provided on the thickness of these sand layers.

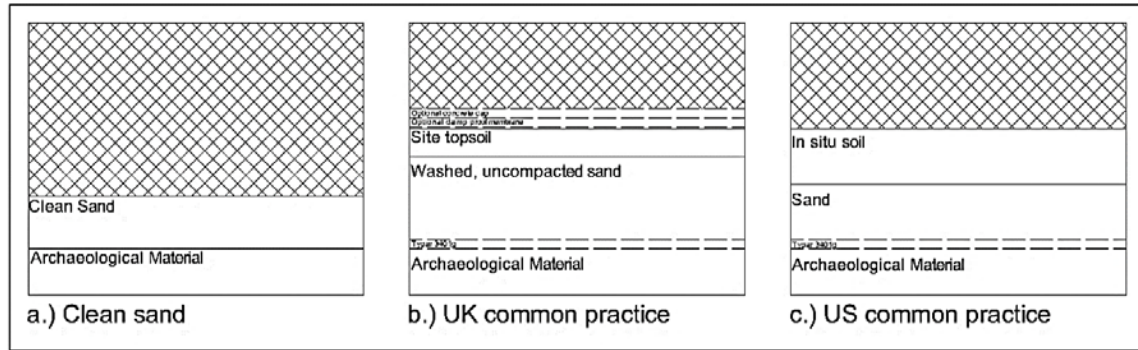

Figure 3.5 Schematics of General Use Reburial Systems. The clean sand reburial system is shown in 1.a, as are the U.K. common practice (1.b) and US common practice (1.c)

### 3.3.1.1 Clean sand

Figure 3.5.a represents the simplest reburial system, where a site is backfilled with clean sand to ground level (Canti and Davis 1999). Backfilling with the same soil removed from the excavation was the preferred method for early reburial projects because it was affordable and uncomplicated (Demas 2004). As legislation in the U.K. changed to promote in-situ conservation, using clean sand instead of the excavated soil became common (Canti and Davis 1999). The reason why clean sand was chosen is due to it being chemically inert, and low in potentially damaging salts such as chlorides, carbonates, and iron compounds and thus “*should pose no threat to the underlying stratigraphy*” (Canti and Davis 1999). In this reburial system, there is no material separating the backfill from the archaeological material and natural soil, and the backfill is not compacted. However, the placement of the backfill may impact the compaction state of the sand. Even direct dumping of sand from a truck can have a compacting effect, due to the height of drop. Chang et al. (2006) found relative densities of approximately 60 % when studying a reclamation project in Changi, China in which the upper layers had been placed by direct dumping. Clean sand is defined as soil comprised predominantly of sand-sized particles

with less than 5% of the total mass containing fines (silts and clays). However, it is important to recognize that such a pure and chemically inert sand may be a premium commercial product in certain locations (Canti and Davis 1999). Instead, sands with higher fines content can be washed to produce clean sand. While this method creates a rudimentary system, clean sand is effective for sites that only require protection from atmospheric exposure and will not be subjected to mechanical (e.g., site construction) or environmental (e.g., acid rain infiltration) stresses. Therefore, this reburial system is unsuitable for sites that are expected to be developed.

#### 3.3.1.2 UK common practice

The most common practice (Figure 3.5.b) in the United Kingdom (Goodburn-Brown and Hughes 1996) is to cover the archaeological material with a permeable, non-woven geotextile (usually a polymer fabric with long life expectancy) followed by a layer of washed sand and then excavated soil from the site as a cap. Sometimes, the reburial system is capped with a damp-proof membrane and then concrete. Neither the sand nor the in-situ soil are compacted, which can lead to problematic situations. After re-excavating a previously reburied site, the sand was found to “*flow like water*” (Goodburn-Brown and Hughes 1996), which made for an added difficulty during the re-excavation of the site. Because of this issue, the use of damp sand is recommended. Although Goodburn-Brown and Hughes don’t elaborate on the reasoning behind the recommendation, a possible reason is that adding water to sand gives it apparent cohesion. This would mean that the sand would be able to stand to a certain height, much like when building sandcastles. The amount of water should be carefully monitored as the sand will lose this apparent cohesion if allowed to dry or become saturated. However, in the absence of compactive effort applied

to the sand, the issue is likely to remain. Allowing for fine content in the sand would greatly aid this issue, as even just a small amount of fines (15 – 20 %) can give cohesion to a soil.

#### 3.3.1.3 US common practice

US common practice (Figure 3.5.c) (Kavazanjian 2004; Thorne 1991a) is similar to UK common practice. The archaeological material is covered with a non-woven geotextile, and the excavation is backfilled with clean sand. The reburial system is capped with soil from the site. Common practice in the US calls for the backfilled sand to be compacted, but does not give any guidance on compaction for the in-situ soil. However, as a result of compaction, the hydraulic conductivity of the sand layer tends to be less than what is achieved with UK common practice. Since the sand is compacted using mechanical equipment, this reburial system can be unsuitable for sites with fragile archaeological material. Thorne (1991) recommends placing the fill in layers, and that the layer closest to the archaeological material should be thick enough to prevent compaction related damage. He also recommends that the personnel performing compacting operations be briefed on the nature of the archaeological material so that the necessary care during operation may be applied. Compacting the sand backfill increases its density and shear strength, which in turn improves bearing capacity and reduces compressibility (i.e., potential for future settlement). This reburial system is therefore more appropriate for sites where future construction and development are anticipated.

#### 3.3.1.4 Mosaic reburial

The mosaic reburial system (Kavazanjian 2004; Mora 1986) (Figure 3.6) was proposed for the conservation of mosaics and related archaeological material (such as frescos, plasters, and other murals), oriented either in a horizontal plane (i.e., in a floor) or in a vertical plane

(i.e., in a wall). There are no known published studies on the implementation of this proposed reburial system. The system is designed to prevent moisture infiltration and temperature changes that accelerate the deterioration process of mosaics. To this end, a “plastic net with fairly close mesh (e.g. of the type used for protection against hail)” (Mora 1986) is placed over the remains to provide protection to the archaeological remains. Because the main goal of this system is to prevent the movement of water, Kavazanjian recommends the use of a geosynthetic clay liner (GCL). The schematics represent this upgrade to the original design proposed by Mora. A GCL is composed of a thin layer of expanded clay pellets sandwiched between two geosynthetics or attached with adhesive to a geomembrane. The geosynthetics may vary according to the design, however a GCL will greatly impede the passage of water. A layered composite soil system comprised of vermiculite, bentonite, and topsoil (soil from the site may be used) is placed on top of the double GCL system. Mora (1986) also suggests that shallow-rooted vegetation be placed on top of the reburial system. This vegetation increases protection to the remains by providing resistance to erosion and providing protection from small animals.

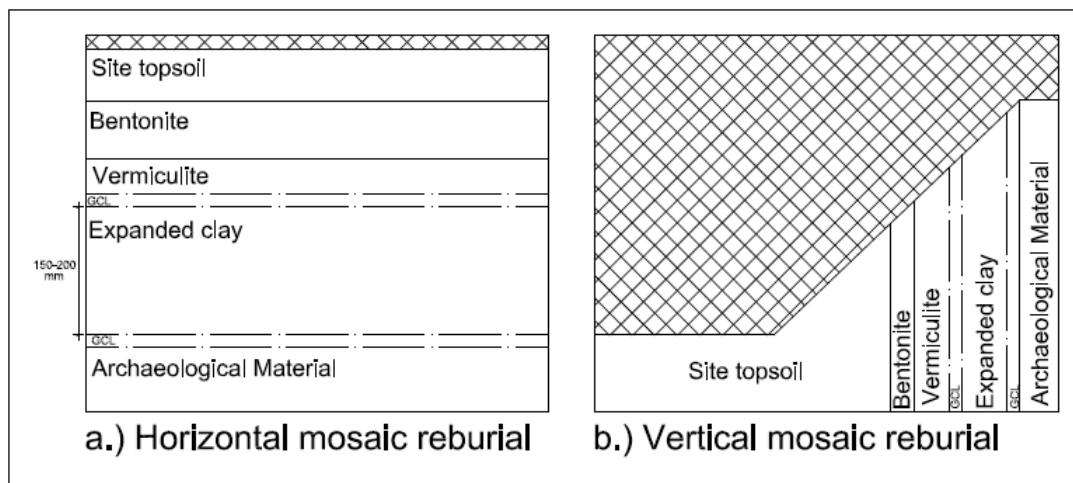

Figure 3.6 Schematics of Mosaic Reburial Systems, either horizontal (2.a) or vertical (2.b).

### 3.3.2 Site Specific

Although there have been many site-specific reburial systems, the following four examples were chosen as representative of the range of options available. The first two (the Rose Theatre and the New Rose) were chosen both for the significance of the Rose in the reburial movement and for the great amount of published data about it. Although the New Rose reburial system has not been installed yet, the project has been approved and is only depending on funding. The third case presented, at Bristolkvartalet, is interesting as both an example of a reburial outside the U.S.-U.K. area, and as a complex reburial system designed to protect the archaeological material from construction related loads. The last system, which is unique because it was designed by an engineering geologist, is also distinctive due to its design which uses only a combination of site and borrow soil. The reburial systems can be seen in Figure 3.7. Although these were designed for specific cases, they could be adapted to archaeological sites in similar situations.

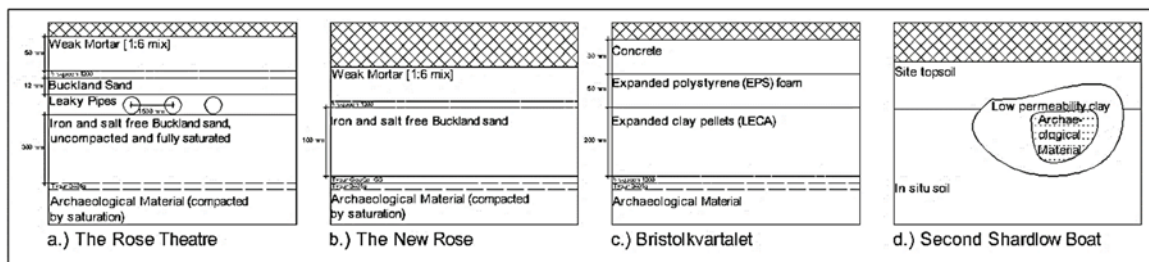

Figure 3.7 Schematics of Site Specific Reburial Systems. The original reburial system installed at the Rose is shown in 3.a, while the proposed system is shown in 3.b. Schematics for the Bristolkvartalet system (3.c) and the second Shardlow boat (3.d) are shown.

#### 3.3.2.1 The Rose Theatre

The reburial system for the Rose Theatre (Figure 3.7.a) is relatively complex, and its completion was complicated by the low headroom available and the short timeframe in



which the project had to be accomplished (Corfield 2004; Wainwright 1989). Excavation of the site and implementation of the reburial system all had to be performed during a break in construction for the overlying building. A significant amount of archaeological wood was present at this site, and it was necessary to prevent decay by maintaining a saturated environment for the wood. To this end, the Rose Theatre reburial system builds on UK common practice by adding a “leaky pipe” irrigation system that provides a readily available source of water to control saturation. The pipes were installed 1500 mm apart throughout the width of the reburial system, and the pipes were covered with sand and impermeable polyethylene sheeting (Visqueen). Buckland sand was used for site reburial because it is a well-known, high quality, pure silica sand which is chemically inert. While the sand was uncompacted, it must be noted that the expected stress transfer to the sand was small because of the unique foundation system used to support the overlying building (Biddle 1989). Furthermore, a weak mortar capped the reburial system to protect it from accidental construction-related damage.

#### 3.3.2.2 The New Rose

Although the reburial system at the Rose Theatre has been successful, it was designed as a temporary solution to ensure immediate preservation of the archaeological remains. In the years since its discovery, however, the site has been used as a theatrical venue, but the current conditions are not as comfortable as desired. A modified reburial system was designed (Figure 3.7.b) (Corfield 2012) to provide more headroom for entertainment and visitor facilities at the site and accommodate the future installation of a glass floor to enhance the visitor experience. The new design is indicative of the prominence the Rose Theatre has gained and of the progress that has been made to preserve, and even showcase,

archaeological remains for the general public. One of the goals of the new design is that “*waterlogging of the soils must be maintained by the natural groundwater regime of the site and its environs*” which in conjunction with the need to create more headroom to accommodate visitor meant that the “leaky pipe” irrigation system was removed. Because of this, the thickness of the sand was reduced as well. The new design also incorporates a geocell (Erocell, marketed as Typar GeoCell GS in the U.S.), which will be filled with reused Buckland sand that will be removed from the existing reburial system to act as a “*load spreading layer*” (Corfield 2012). Although progress is still ongoing, it is expected to be implemented in the near future (Corfield 2012).

### 3.3.2.3 Bristolkvartalet

When medieval ruins (the remains of a vaulted room) were found during the construction of a new hotel at Bristolkvartalet, Trondheim in Norway, the decision was made to preserve them in-situ (Johnsen 2009; McLees 2008). The ruins, as shown in Figure 3.8, were radiocarbon dated to 1280-1295 A.D., and ceramics found at the site indicated that they had been in use in the 17<sup>th</sup>-19<sup>th</sup> centuries and early parts of the 20<sup>th</sup> century. The ruins were protected under the 1978 Norwegian Cultural Heritage Act, and as such there was a request for the ruins to be displayed to the public. The developer opted against it due to economic reasons, and so the remains were fully excavated and then reburied.

The reburial system at Bristolkvartalet (Figure 3.7.c) was designed for site-specific conditions. The main purpose of the reburial system was to “*distribute the weight of the building across the ruin*” (Johnsen 2009). As part of the negotiations, the developer agreed not to use the basement at the hotel, which provided sufficient space to install the reburial system. A non-woven geotextile was placed directly on top of the archaeological layer and

covered with plastic sheeting to maintain the moisture within the ruins. A layered composite system was then constructed on top of the plastic sheeting to distribute and reduce the applied stresses from the new building. The design incorporated a 20 cm thick layer of expanded clay pellets that were installed in loose form, rather than contained in bags. A 5 cm thick layer of lightweight and compressible expanded polystyrene (EPS) foam was placed on top of the pellets, and the entire system was capped with an 8 cm thick layer of concrete.



Figure 3.8 Wall and pillar foundation of a vaulted room in the medieval ruins at Bristolkvaralet. The exposed remains of the ruins can be seen as they were before the reburial system was put into place (from McLees 2008).

#### 3.3.2.4 Second Shardlow Boat

Sometimes, the unique nature of archaeological remains at a given site is the most significant and determining factor in the design of the reburial system. When a second Shardlow boat (Williams et al. 2008) was found during normal operations at an English quarry, it was quickly decided that preservation in-situ would be pursued. Previously, a 10.5 m long Bronze Age boat had been discovered at the quarry. There was no provision for handling archaeological remains because the permit that regulated activities in that section of the quarry was outdated. In lieu of reburial, funding was acquired to excavate and transfer the boat to its current location at the Derby Museum and Art Gallery. When the second boat was found, reburial was preferred (as in-situ conservation was determined to present the best chance for survival of the boat) and made possible due to new legislation (Planning Policy Guidances 15 and 16 (Department for Communities and Local Government 1990, 1994)) that was enacted after the discovery of the Rose Theatre.

To prevent deterioration of the fragile timbers, a reburial system (Figure 3.7.d) was designed to keep the remains saturated using only natural materials. Because of environmental conditions, the site was too wet for work to begin on the permanent reburial for approximately a year and a half. During this time, the exposed portions of the boat were covered in 1.5 m of organic silts present at the site and submerged under 1 to 2 m of water. When the permanent reburial system was installed, the temporary covering was removed, leaving only the in-situ soil. Figure 3.9 (from Williams et al. 2008) shows the stern of the boat during the installation of the temporary reburial system. The permanent reburial system shrouded the exposed areas of the boat within a low permeability clay bund. The clay bund extended into the natural soil surrounding the boat to prevent the development

of unsaturated conditions from ground water table fluctuations. The exposed surface of the bund was then covered with soil from the site, creating a mound that was well marked to prevent future quarry operations at that location.



Figure 3.9 Close up photograph of the top of the transom of the second Shardlow boat (from Williams et al. 2008).

### 3.4 Reburial cover materials

Table 3.2 presents an overview of the eight reburial systems discussed above along with a qualitative assessment of stiffness, thickness and installation time. On the materials used we can see that although most reburial systems, with the exception of Bristolkvarvalet, choose to use borrow soil. Although no borrow soil is needed, the system does incorporate a soil based product (expanded clay pellets) and other manmade materials. The borrow soil

most commonly used is a clean sand, which is desirable for being chemically inert and having a high permeability coefficient, which facilitates draining. Other borrow soils which are sought are clays, which both possess a low coefficient of permeability. Half of the reburial systems use the in-situ soil, either as a part of the reburial system or as a cap for the entire reburial system. Although it is often financially enticing to use in-situ soil as part of the design, chemical tests must be performed to ensure that the soil will not contain properties that can be deleterious to the archaeological mater, such as high redox potential or acidic pH.

Because headroom is often a driving factor in choosing which reburial alternative is chosen, a qualitative assessment of the reburial system thicknesses is given in Table 3.2. It must be pointed out that general use reburial systems classify as thin because of the flexibility afforded in their dimensions due to the vast range of situations they should fit. Those reburial systems may be adapted to be thicker if the situation at the site allows it.

The last column in Table 3.2 .presents a qualitative description of the installation process. It is important to ensure that the workforce is sufficiently qualified to correctly install the reburial system. Improper training can lead to great problems during installation, as was discovered in the Chaco Canyon reburial project (Ford and Demas 2004). As this can significantly impact the budget for the project, it is necessary to consider both the cost of materials and of the installation of the reburial system. While material costs are somewhat similar in different markets, the cost for qualified workers to install the reburial system are liable to change

Most of the systems, which do not use natural soil (75 percent), have a concrete or mortar layer to cap the reburial system. Reburial systems which are designed to withstand the burden of overlying construction (both of the designs for The Rose and Bristolkvarvalet) include a cement based cap to the design to better protect the archaeological material. This results in a stiff reburial system instead of a flexible one, which may present local deformations if subjected to concentrated loads such as a footing for a building.

Non-woven geotextiles are the most popular geosynthetic for reburial systems. This material is often paired with plastic sheeting, and all of the reburial systems which incorporate sheeting also use a geotextile. Geosynthetic clay liners (GCL) and geocells are used sparingly, with the use of the former coming as an upgrade to the original design. The use of a geocell presents interesting opportunities, as the material which is used to fill the cells can be changed depending on the specific needs of the project.

### **3.5 Reburial system taxonomy**

The lack of standardized reburial design guidance has also limited efforts to sufficiently categorize reburial projects. Johnsen (2009) proposed that reburial systems should be classified as permanent or temporary, since the anticipated life span of reburial will strongly impact the design. However, the life span can be hard to determine, and it is liable to change. Although reburial projects are often initiated as a temporary measure, their life span is prone to be extended. A good example of this is the reburial of the Rose Theatre, which was designed as a temporary reburial (Johnsen 2009) but became a semi-permanent solution; it is only recently that a more permanent solution has been initiated (Corfield 2012).

Table 3.2 Overview of the reburial systems and their components

	Materials							Properties			
	Natural Soil	Borrow Soil	Concrete	Geosynthetics				Other Materials	Thickness	Stiffness	Installation Time
				Geotextile	Sheeting	GCL	Geocell				
Rose		Clean Sand	Weak Mortar	X	X			Leaky Pipes	Thick	Stiff	Long
New Rose		Clean Sand	Weak Mortar	X	X		X		Medium	Stiff	Medium
Standard US	Yes	Clean Sand		X					Thin	Flexible	Quick
Bristolkvarvalet			Concrete	X	X			Expanded Polystyrene and Expanded Clay Pellets	Thick	Stiff	Long
Clean Sand		Clean Sand							Thin	Flexible	Quick
Second Shardlow Boat	Yes	Kaolinite							Medium	Flexible	Long
Mosaic Reburial	As a cap	Bentonite				X		Vermiculite and Expanded Clay Pellets	Thick	Flexible	Long
Standard UK	As a cap	Clean Sand		X					Thin	Flexible	Quick



Given the uncertainty in the useful life of a reburial system, it is perhaps better to classify reburial systems in terms of performance expectations. Most in-situ conservation strategies are intended to protect remains from one principal source of damage, which can arise from either changes in subsurface environmental conditions or changes in applied forces across a site. Since reburial systems are often designed to meet certain performance standards, while keeping in mind a number of site-specific considerations, a taxonomy based on designed performance seems to be more appropriate.

### **3.5.1 Proposed performance-based classification**

A new, performance-based classification for reburial systems based on the research presented in this document is shown in Figure 3.10. The proposed classification is based on an assessment of (1) the principal source of potential damage (that the reburial system is designed to protect against) and (2) the reburial system complexity (needed to achieve the expected level of protection). A two-letter designation is suggested for classification. The first letter indicates the principal source of damage as either mechanical (M) or environmental (E). The second letter indicates whether or not the reburial system is considered to be simple (S) or complex (C).

There are two important benefits of using this classification approach. First, it is purposefully constructed to provide a simplified basis of categorization. With only four possible designations, it should be reasonably straightforward to utilize. As more reburial systems are implemented, the classification can be expanded or refined. Second, the classification is linked directly to design because it identifies the controlling design factor

and the extent of required system components. In the future, as reburial system design guidance evolves, so should the classification of reburial projects.

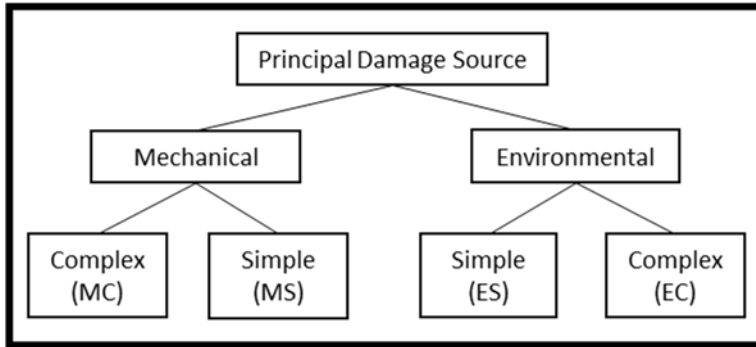

Figure 3.10 Proposed classification for reburial systems.

### 3.5.2 Damage Mechanisms

Archaeological remains are vulnerable to changes in mechanical and environmental conditions (Mathewson and Gonzalez 1988). When designed and constructed properly, reburial systems can provide protection against potential damage from multiple causes. In most cases, however, there is likely a primary source of damage, which is of greatest concern to the long-term integrity of the archaeological material. This source should be designated as the controlling factor in the design of a reburial system. Table 3.3 outlines the potential sources of damage.

Mechanical damage can be defined as that which causes the deformation or relative displacement of archaeological material. Deformation is the change in shape or size of an artifact, and it can range from insignificantly small changes to severely large changes. At its extreme, deformation can lead to destruction of an artifact.

Table 3.3 Potential damage sources and conditions

	Damaging Condition	Possible Damage Sources
Mechanical	Compression	Overlying construction, heavy equipment, compaction activities
	Movement	Earthquakes, compaction activities, pile-driving, root penetration
	Vibration	Earthquakes, compaction activities, pile-driving
	Artefact damage	Root penetration, macro-organism activity
Environmental	Acid and basic environments	Acid and basic infiltration
	Wet aerobic and anaerobic environments	Water infiltration
	Wet-dry cycles	Groundwater table movement
	Micro-organisms	Bacterial activity
	Freeze-thaw cycles	Water infiltration in shallow burials
	Salts transport and crystallization	Water movement through reburial system
	Reduction-oxidation processes	Water infiltration
	Cementitious materials leakage	In-situ pile casting, construction activities

Relative displacement is the movement of an artifact within its buried environment, which results in a positional change. This results in the destruction of the archaeological contextual information, which is often more important than the artifacts themselves. Mechanically induced damage to archaeological remains is most commonly caused by anthropogenic activity on or near the ground surface. Common causes include compression of the archaeological material due to an increase in applied load due to overlying construction, or vibrations due to construction activities like pile-driving. An increase in the overlying load can severely damage the archaeological material, and vibrations may negatively impact the preservation of the archaeological context by inducing movement in the soil. Deep foundations (both driven and cast in place) present their own set of problems, and have been the subject for publications on their impact on buried archaeological remains (English Heritage 2007; Environment Agency 2006). Cast in place piles displace the soil and disrupt the stratigraphy close to the pile, destroying archaeological material and context around them. Driven piles will commonly, construction activities at the site will take place after the reburial system has been placed. Root penetration from deep-rooted vegetation

growth at the surface can cause artifact damage and artifact displacement as the roots grow in the subsurface. Although this is a biological process, it causes mechanical damage.

Environmental damage occurs when the archaeological material degrades due to chemical, physical, or biological processes in the buried environment. Damage to the archaeological material may come from chemical processes (such as reduction-oxidation or acid-basic reactions) organic processes, such as microorganisms degrading archaeological wood, or from physical changes in the environment, such as a rising or falling groundwater table, or freeze-thaw cycles. Changes in groundwater level and chemistry are the most important factors in environmental damage. Archaeological remains may be very sensitive to changes in moisture content (mosaics need to be kept dry, whereas wood needs to be kept at a constant moisture level), groundwater chemistry (pH and redox potential), or microbial activity. The movement of water through soil can also transport salts which crystallize on the archaeological material, damaging it. Due to the impact of water on site preservation, reburial systems focused on protecting the site from environmental damage will often focus on controlling site hydrology. Another possible cause of damage is due to leakage of cementitious material (such as concrete for an in-situ cast pile) into the archaeological layer.

### **3.5.3 Reburial System Complexity**

All reburial systems use soil as either a working element in the system or as a cap. Most systems use some combination of borrow soil (such as clean sand or low permeability clay) and the soil present at the site (often as a cap). In the simplest case, soil is the sole material used for reburial. Placing the removed soil into the excavation was the earliest use of

reburial as a conservation measure (Johnsen 2009). However, unless there was a design process that resulted in that solution; that is more akin to backfilling than a designed reburial system. It is also common practice to incorporate geosynthetic materials that perform one or more functions within a reburial system. Examples of such materials include geotextiles for reinforcement and separation of layers, plastic sheeting for separation, and geocells or geogrids for reinforcement. Kavazanjian (2004) presents an excellent discussion on the potential uses for geosynthetic materials. Other manmade materials include concrete (for support or as a cap to the system) and irrigation or drainage pipes.

The proposed classification for system complexity is based on the extent of components required to meet the performance expectations. A reburial system which only incorporates soil (in-situ soil or soil from a borrow source, or both) and one manmade material is classified as simple. Systems which have soil and more than one manmade material are classified as complex. It should be noted that this classification approach does not necessarily reflect the difficulties associated with the implementation of a particular reburial system. There can be site-specific conditions, for example, which create significant challenges in the construction of a simple reburial system, such that one might consider it to have been a complex installation.

#### **3.5.4 Application of classification system**

Figure 3.11 shows the proposed classification system applied to the non-exhaustive list of reburial projects which was presented in Table 3.1. Because some of these reburial systems

were not always thoroughly described, the following classifications were made with the best information available.

From Figure 3.11, we can see that the reburial systems chosen are almost evenly split in terms of complexity. Simple reburial systems make a small majority (55 %). However, due to the fact that a majority of the “general use” reburial systems are classified as simple (75 %), it may be that the proportion of simple reburials is much higher in the field.

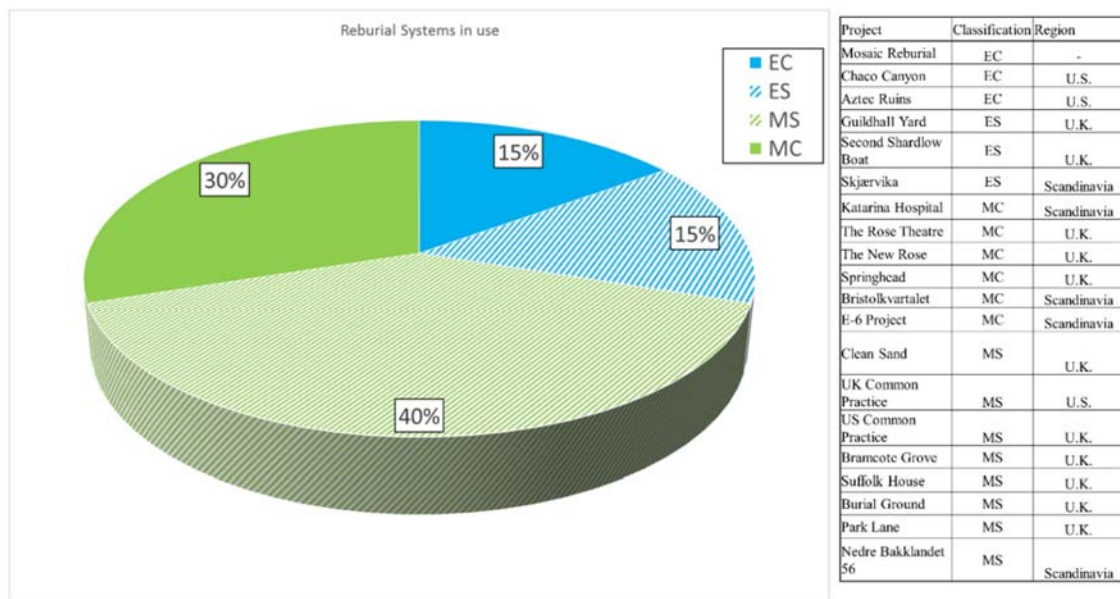

Figure 3.11 Classification of selected reburial systems.

A large majority (70%) of the chosen reburial systems are designed to protect the archaeological reburial from mechanical sources of damage. This can be explained by the fact that reburial is often undertaken to mitigate the effects of overlying construction.

The reburial system used at Suffolk House was designed to protect the archaeological material from damage due to development. The system consisted of a geotextile, which was then covered with fill. Because the system only has soil and other material, and was

designed to protect the archaeological material from mechanical damage due to development, it is classified as MS. Conversely, the Rose reburial system was also designed to protect the archaeological site from the overlying construction, but included many different materials. This, it was classified as MC.

The second Shardlow boat reburial system was designed to protect the wooden remains from fluctuations in the moisture content. This was achieved by using only low-permeability clay, and the in-situ soil; which puts it in the ES category. The mosaic conservation reburial system aims to protect the mosaics from moisture related damage, but to do so it employs a variety of materials, which makes it into an EC.

## CHAPTER 4 DESIGN METHOD

The proposed design guidelines that are presented in this chapter are meant to serve as a first step towards a complete design procedure for reburial systems. These guidelines are drawn from case histories of reburial projects, as well as design knowledge from other engineering works, such as landfills.

Although there is no comprehensive guideline document for the design of reburial systems, there have been recommendations published. These recommendations, as well as the current state of design for reburial systems are discussed in this chapter. Finally, the proposed design method is presented, along with detailed discussion of each element in the reburial system.

### 4.1 Current design challenges

Because there has been little research that presents a quantifiable analysis of reburial system design and performance, there are many challenges standing in the way of a complete design method. These challenges are both archaeological and engineering related in nature, and need to be approached in a multi-disciplinary fashion.

A complete reburial system design method is contingent on overcoming these challenges. To solve these, the cooperation of both the engineering and archaeological communities is needed. The current challenges to producing a design method for reburial systems are:



**a.) There are no accepted guidelines for design:** Apart from common practice reburial systems, all reburial systems are designed on a site by site basis. There are no accepted guidelines for design, which is an added difficulty that can result in ineffective or counter-effective performance. The few guidelines that have been published are presented as a piece of a larger whole. To counteract these, a set of design guidelines should be created, evaluated, proposed, disseminated, and eventually accepted in the community.

**b.) Minimal collaboration between archaeologists and engineers:** Despite calls for more collaboration between the archaeological and engineering communities (Salvadori and Cortes-Comerer 1977; Thorne 1991a; Tilly 1998) there is presently minimal collaboration between these communities. Because a reburial system must meet both archaeological and engineering goals, it is critical that the engineering community become involved in the preservation of archaeological remains. To do this awareness of the problem must be raised in the engineering community by publishing in journals with an engineering audience, or organizing events attended by both communities. It is also important that any proposed design guidelines require the participation of both an archaeologist and an engineer in order to foster cooperation.

**c.) Lack of long term performance data:** Because monitoring is often neglected in reburial systems, there is a lack of long term performance data of reburial systems. With the exception of the Rose, there is no large data set on the performance of a reburial system to provide a stable environment for the archaeological material. There are only a few cases of remains being re-excavated after reburial; so in a lot of reburial system there is no clear understanding of the state of the archaeological material. In order to overcome this challenge, monitoring of reburial systems should be undertaken. The monitoring data

should be made available so that it can be used to assess performance and influence future designs.

**d.) Limited availability of past experiences:** Because case histories are currently the primary source of information about reburial system design and performance it is critical that they be detailed enough and readily accessible. Published case histories on reburial systems should include all the necessary design parameters (soil properties, applied loads to the site, etc...) and the reburial systems installed should be detailed (dimensions, materials, etc...). Well-documented case histories should be readily published and accessible to both the archaeological and engineering communities.

**e.) Limited knowledge of decay processes:** There is a limited knowledge of the decay processes that buried archaeological material goes through. Although there have been large scale experiments (Crowther et al. 1996; Lawson et al. 2000) a comprehensive and quantifiable framework for decay processes has not been established. To design a burial environment conducive to the conservation of archaeological material, knowledge on how the archaeological materials becomes damaged is essential. To overcome this challenge, research needs to be undertaken in this subject. Both laboratory experiments and computer modelling could give us a quantifiable framework for understanding decay processes. This can be complemented by drawing on the available literature about mechanical and chemical processes affecting archaeological material.

**f.) Lack of inter-disciplinary knowledge:** Because reburial systems must meet both archaeological and engineering performance standards, it is necessary that the involved engineers have an understanding of the archaeological principles of conservation, and that

the archaeologists have an understanding of the engineering properties of the materials in the reburial system. This can be solved by publishing and disseminating reburial system design guidelines that cover both the archaeological and engineering principles used in the design of a reburial system. This will lead to cooperation between the parties. Publications in both archaeological and engineering journals about reburial design should also facilitate acquiring the necessary knowledge.

**g.) Lack of geotechnical site data:** Because the in-situ soil is responsible for conserving the material until excavation and will continue to play an important role in the conservation of the archaeological material, it is critical that the necessary geotechnical data may be acquired. Currently, published case histories often omit including the site soil data. To ensure that the required data is available, design guidelines should specifically list which soil properties are important for reburial, how they affect the reburial system, and how to determine their values. If there is to be construction at the site post-reburial, the engineer in charge of the construction can and should provide the available data for the site.

**h.) Lack of quantifiable performance goals:** Because of the absence of a quantifiable understanding of the decay processes of buried archaeological remains, current designs lack quantifiable performance goals. It is necessary to perform research (laboratory or modelling based) to determine the optimal range of conditions for buried archaeological material. This should result in the creation of material performance based guidelines.

Table 4.1 summarizes the design challenges and solutions. It can be seen from this table that most solutions to current design challenges involve one of three activities: a.) closer collaboration between archaeological and engineering communities, b.) more quantifiable

research to inform reburial system design, and c.) publication which discuss reburial that are detailed and available to all parties.

Table 4.1 Current design challenges and solutions.

Challenge	Solution
No accepted guidelines for design	Creation of design guidelines
Minimal collaboration between archaeologists and engineers	Joint publications and research
Lack of long term performance data	Ensure monitoring data is collected, analyzed, and published
Limited availability of past experiences	More detailed and easily available publications
Limited knowledge of decay processes	More research into decay processes
Lack of inter-disciplinary knowledge	Cooperation between communities
Lack of geotechnical site data	Cooperation between communities
Lack of quantifiable performance goals	More research to determine optimal conservation ranges

## 4.2 Design philosophy

The rationale behind developing the DAISEE (Design of Archaeological InfraStructure for Elective Entombment) guidelines presented in this document was due to a lack of a recognized design method for archaeological reburial systems. Because of this, design is often on a site by site basis, with little guidance available. This has led to *“ineffective, and sometimes counter-effective performance”* (Kavazanjian 2004).

### 4.2.1 Design process

To design a set of guidelines for archaeological reburial systems, a design process was followed. There are many proposed design processes that are available, and most of them share similarities. However, the engineering design process proposed by NASA (NASA 2008) and shown in Figure 4.1 was used.

In this process, there are 7 steps to design. We can apply this design process to the design of a reburial system, using both the information available in the literature and the DAISEE guidelines.

The first step is to identify the problem. This step constitutes in determining that in-situ conservation will be undertaken at the site. This is often due to construction activity being undertaken at the site. The second step identifies the criteria and constraints. In this step engineering, archaeological, legal, and all other constraints on the site should be identified. In the third step, possible solutions are brainstormed. It is in this step that reburial may be proposed, and chosen, as the optimal in-situ conservation alternative.

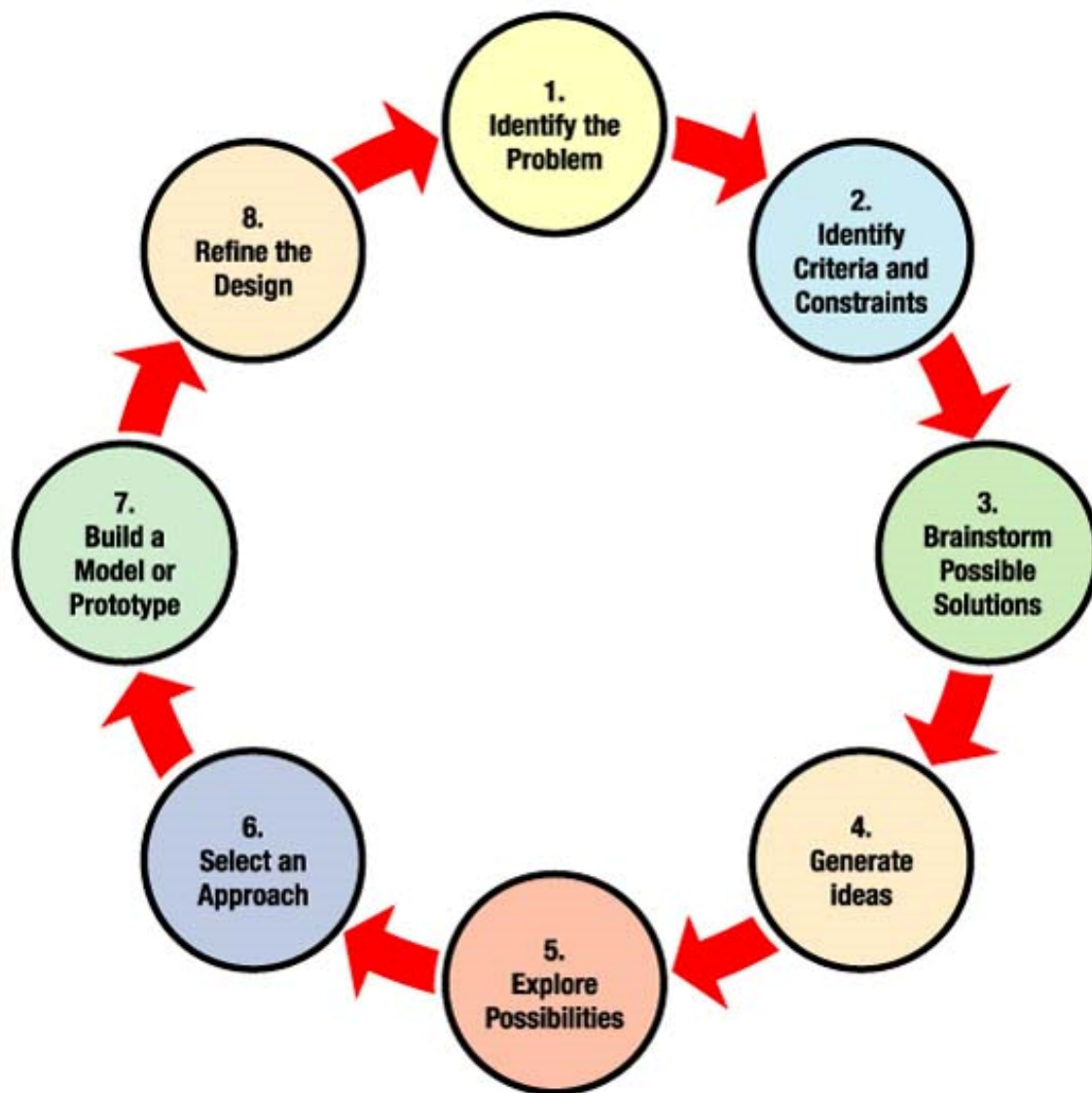

Figure 4.1 NASA engineering design process.

The fourth step is to generate ideas about the reburial system design. It is in this step that various possibilities about how to design the reburial system are proposed. Possibilities may include using a common practice reburial design, producing a reburial system design using the DAISEE guidelines, or designing a site-specific reburial system. In the fifth step these possibilities are explored and their expected performance (both archaeological and engineering) is evaluated. Based on this, an approach is selected in step 6. This approach produces a reburial system prototype in step 7, which is then refined in step 8. If the DAISEE guidelines were the approach chosen, step 8 will consist of ensuring that the proposed design will meet both archaeological conservation goals and engineering performance goals.

Currently, the DAISEE guidelines cover steps 4, 5, 6, and 7. The guidelines produce a prototype for a reburial system, which may need to be refined. In order to refine the produced design, both archaeological and engineering knowledge are required to ensure that the reburial system satisfactorily meets both archaeological and engineering performance goals.

In order to refine the DAISEE guidelines, current design challenges need to be overcome. Quantifiable research into the decay processes of buried archaeological materials, and into the interactions between archaeological deposits and reburial system is needed; as well as long term performance data from existing reburial systems.

#### 4.2.2 Philosophy statement

The vision for the DAISEE guidelines is to have a design system which is based on providing a reburial environment suitable for the in-situ conservation of archaeological remains. The design system needs to account for the intrinsic properties, inherent variability, and decay processes of the archaeological material and integrate them with geotechnical engineering principles to produce a reburial system that can both ensure the preservation of the archaeological material and meet the engineering needs placed on the site.

In order to effectively design a reburial system, first the decay processes of the archaeological material in a buried environment need to be better assessed. Then, the interactions between the archaeological material and the buried environment (for example the chemical processes between the assemblage and the groundwater, or the mechanical behavior of archaeological inclusions in a reburial system) need to be better characterized. Finally, real world applications of the design system should be published as detailed case histories which include details on both the site conditions and the post-reburial performance of the reburial system.

Although there has been work to characterize the decay processes of buried archaeological material (Agnew, Selwitz, et al. 2004; Björndal and Nilsson 1998; Crowther et al. 1996; Hester 1988; Lawson et al. 2000; Mathewson and Gonzalez 1988) a quantitative approach is necessary. Such an approach should focus on determining the optimal range of conditions for preservation of different types of archaeological material in a buried environment, as well as the damage potential outside of that range. In order to achieve this,

the physical, mechanical, and chemical properties of archaeological material must be established. Once the material properties have been determined, the decay processes can be characterized. This can be done by testing archaeological material in laboratory or field conditions.

Secondly, the interactions between the archaeological material and the reburial environment need to be characterized. Once the material properties and decay processes of the archaeological material have been determined, the interactions between archaeological remains and burial environment must be studied. Shilston and Fletcher (1998) proposed numerical modelling of buried archaeological sites. Large scale testing of buried archaeological material can also be used to examine the interactions between archaeological material and burial environment.

Finally, publications detailing reburial case histories should be more detailed. If reburial was undertaken due to construction activities, or other human activity at the surface, details on the post-reburial land use should be included. These can be loads applied to the site, changes in infiltration rates and subsurface hydrology, or other changes to site conditions. The site needs to be thoroughly assessed both from a geotechnical engineering perspective (soil properties, soil stratigraphy, etc...) and an archaeological perspective (type of archaeological material, condition of the remains, etc...). The design method used should be described, as well as the rationale behind the design. Decisions regarding reburial system design and materials should be explained, and based on expected performance. Monitoring of the reburial system to ensure that it meets both the required archaeological and engineering goals must be undertaken, and the results must be published.



The DAISEE guidelines should be used for the design of reburial systems by both archaeologists and engineers who are tasked with in-situ preservation of archeological sites. Because the design process is not yet finished, some outside knowledge on reburial systems is currently required to fully understand the design process. However, as the design method is continually refined and updated, it will eventually be self-contained requiring only the necessary design inputs to produce a reburial system design. The ultimate goal is to produce a design method which can be used by both engineers and archaeologists in collaboration with one another, but where each member understands both the engineering and archaeological principles used in the design method.

#### **4.2.3 Reburial design goals and objectives**

The near-term goals for the DAISEE guidelines are to increase visibility for the design system, and to refine the design process. This will be done by using real world performance data when available, and using research to solve the present challenges. The long-term goals are to achieve a complete design system, which thoroughly assesses and quantifies the site conditions and the archaeological material to determine the optimal reburial system alternative. Another long-term goal is for the design process to have enough visibility in the practicing archaeologist community so that it is used (or at least guides or influences) for the design of real world reburials.

To achieve these goals, various objectives must be met. The most pressing objectives are:

a.) Disseminate the DAISEE guidelines to increase visibility in both the engineering and archaeological communities. This can be done by publishing in the appropriate venues,

such as engineering and archaeological journals and conferences. This brings the benefit of peer evaluation for the design guidelines which can be used to refine the process.

b.) Research the decay processes of buried archaeological material, so that quantitative performance goals can be established for reburial systems.

c.) Field test the DAISEE guidelines in a real world setting to gather performance data. This will serve to evaluate the current design method, and to inform the revisions to the design.

d.) Propose publishing guidelines for reburial case histories. Because performance data is needed to assess the effectiveness of the design method, both the design processes followed and the monitoring results should be published. These publications should have a great level of detail regarding the conditions at the site such as site soil properties, external processes affecting the site, detailed overview of the archaeological assemblage composition and state, and all other information necessary for design. It is also important that monitoring of the performance of the reburial system be undertaken, and the data published. This information is crucial to refining the design method.

#### **4.3 Current state of design for reburial systems**

The conservation of our historical heritage is an important, yet often overlooked, responsibility of the civil engineer. Due to the modern day rate and scope of development, which results in larger buildings with a shorter utility life, underground archaeological remains are now in danger of being irretrievably lost. Salvadori (1976) studied the state of archaeological conservation, and concluded that unless immediate action was taken, a large portion of U.S. archaeological sites would be lost to construction. Perez-Mejia and Pierce

(2013) offer an update to Salvadori's article, discussing the current state of collaboration between the civil engineering and archaeological communities. Mathewson (1989a) identifies three scenarios in which construction projects can negatively impact the survival of an archaeological site: 1) projects requiring excavation, 2) projects which alter the natural geological system and accelerate the natural processes which threaten a site, and 3) projects requiring site burial or inundation.

In recent years, in-situ conservation has gradually displaced preservation by record as the preferred conservation option for archaeological sites (Corfield 1996). As preservation by record includes the excavation, study, and removal of archaeological material from its original context, much of its research potential is lost (Johnsen 2009). In-situ conservation also allows for future display of the remains if they are deemed historically or aesthetically significant, as in the case of the Rose Theatre (Ashurst et al. 1989; Corfield 2012; Wainwright 1989). Reburial presents an attractive in-situ conservation option, as it both protects the archaeological material and allows for development of the site (Demas 2004). It is also flexible as both excavated and unexcavated remains can be reburied. However, most current reburial designs have been *“ad hoc solutions rather than engineered applications, sometimes resulting in ineffective or less than optimal performance, unnecessary cost and, at times, even counter-productive (damaging) field performance”* (Kavazanjian 2004). Stewart (2004) states that *“most reburial interventions in Britain have been based on empirical evidence or subjective judgment. Few are deliberately ‘designed’ with clear conservation objectives”*. The chief factor is that there currently is no accepted design methodology for reburial systems. Although there are “common practice” designs, most reburial systems are entirely designed on a case by case basis (Perez-Mejia, Pierce,

and Leader 2013). Most reburial systems are designed without the input of an engineer, something which has prompted the archaeological community to seek collaboration (Thorne 1991a).

The preservation of reburied archaeological material depends mainly on maintaining a reburial environment which promotes the conservation of the material present at the site. As the archaeological assemblage of each site is highly variable, the optimum environment for each case is different. Commonly, the optimum environment is very similar to the environment present before excavation. However, as specific conditions impact archaeological material differently (an acidic environment will enhance preservation of plant matter but quickly degrade osseous matter) the optimum environment for reburial is ultimately determined by the material present at a site.

Reburial has been a conservation option used since the late 19<sup>th</sup> century (Johnsen 2009). In 1931, the general conclusions of the ICOMOS Athens conference recommended reburial as the preferential conservation option (Agnew, Barrow, et al. 2004). The first reburial projects were limited to backfilling the excavated portions of the site, commonly using the material removed during excavation (Johnsen 2009). Although this afforded a measure of protection to the archaeological material from the elements, there wasn't much thought given as to how the excavation process changed the burial environment and the effect this change would have on the preservation of archaeological material. It wasn't until the end of the 1980's that reburial started gaining popularity, mainly due to the case of the Rose Theatre.

Much has been written about the Rose Theatre, both at the time of the project (Ashurst et al. 1989; Biddle 1989; Orrell and Gurr 1989; Wainwright 1989), and in the years since (Corfield 2004, 2012; Greenfield and Gurr 2004). The Rose Theatre can be identified as the premier reburial project, because of the design and complexity of the reburial system, the wealth of monitoring data which is available, and the effect that the project had on the reburial movement. Shortly after the reburial system was implemented, and due to public pressure generated by the project, new legislation was passed in the United Kingdom (Planning Policy Guidances 15 and 16 (Department for Communities and Local Government 1990, 1994)) which encouraged the use of reburial for in-situ preservation of significant archaeological remains. This led to more reburial projects being undertaken, as well as a significant increase in research activity.

Although research was performed on many aspects of reburial, such as the effect of reburial on particular materials (Björddal and Nilsson 2007; Caple 1994), specific reburial systems designed to maximize the preservation of certain types of archaeological material (Burch and Agnew 2004; Podany et al. 1994; Roby 2004), and possible materials for use in reburial systems (Canti and Davis 1999), a standard design methodology for reburial systems was not proposed.

While a complete design guide is missing, there has been published guidance for the design of reburial systems. Mathewson (1989) assembled a matrix detailing the effects of various soil characteristics on the preservation of archaeological material. Thorne (1991) published a technical note containing useful information about the reburial process. Both Mathewson's and Thorne's work were used as starting points for the design method presented in this chapter.

Goodburn-Brown and Panter (2004) present a discussion on the state of research for reburial systems. They state that while the awareness of in-situ preservation and reburial has increased, this has not come with advances in the necessary knowledge to successfully implement these conservation options. Although broad definitions of necessary conditions for the survival of archaeological material have been defined, it is necessary for more research to be carried out. Areas of reburial which are not completely understood include the interactions between archaeological material and different types of soil, the impact of construction activities (including the placement of the reburial system) on the archaeological material, and the long term impact of construction overlaying the reburial system.

Stewart (2004) states that *“even on unexcavated sites, an understanding of the myriad of dynamic parameter, such as oxygen levels, pH, redox potential and their effects is at its infancy. In planning a reburial, therefore, an interdisciplinary approach is essential – not only between the archaeologist and conservator, but also the geologist, soil scientist, materials scientist, civil engineer, botanist or landscape architect”*. This echoes Thorne (1991) who stated that *“In order to determine the best design, a multidisciplinary team of specialists is recommended. This team should include an archaeologist, a geologist, and an engineer”*.

There is much in the field of civil engineering which can be used to further our understanding of reburial system design. In fact, civil engineering technology and materials have already been applied over the last 15 years, especially geosynthetics which have been used extensively (Stewart 2004). Because of the similarities in goals and implementation between reburial systems and landfills, the authors believe that landfill design provides an

excellent first step towards a reburial system design process. In both cases, the goal is to provide a burial environment which meets specific design guidelines. This burial environment is however affected by outside factors, such as further construction, and other anthropogenic activities.

Although using existing knowledge as a base for reburial research is one of the optimal methods through which to start “filling in” our knowledge about reburial systems, it is necessary to remember to frame that knowledge in the context of archaeological research. Performance standards may vary between civil engineering and archaeological projects, and the use of civil engineering technology in an archaeological context may present new issues. For example, Stewart states that adherence of geosynthetics to archaeological surface through the formation of mineral precipitates on and around the fabric is an issue present in a number of re-excavated archaeological sites.

Demas (2004) states that reburial of archaeological sites has commonly been carried out, and for the most part continue to be carried out in a haphazard way. She also states that *“while it may be generally accepted that ‘a fundamental fact in archaeological site conservation is that reburial of exposed archaeological remains is the nearly optimal preservation solution’ there have been few resources other than intuition to guide the process”*. To help alleviate the issue, she presents a decision making process regarding the reburial of archaeological sites (Figure 4.2). Although the process is the closest to a design methodology that can be found in the literature, it focuses mostly on pre-burial considerations and only mentions some technical considerations for burial. However, it is a useful starting point for a design method as it provides some design constraints.

# DECISION-MAKING FOR CONSERVATION INTERVENTIONS

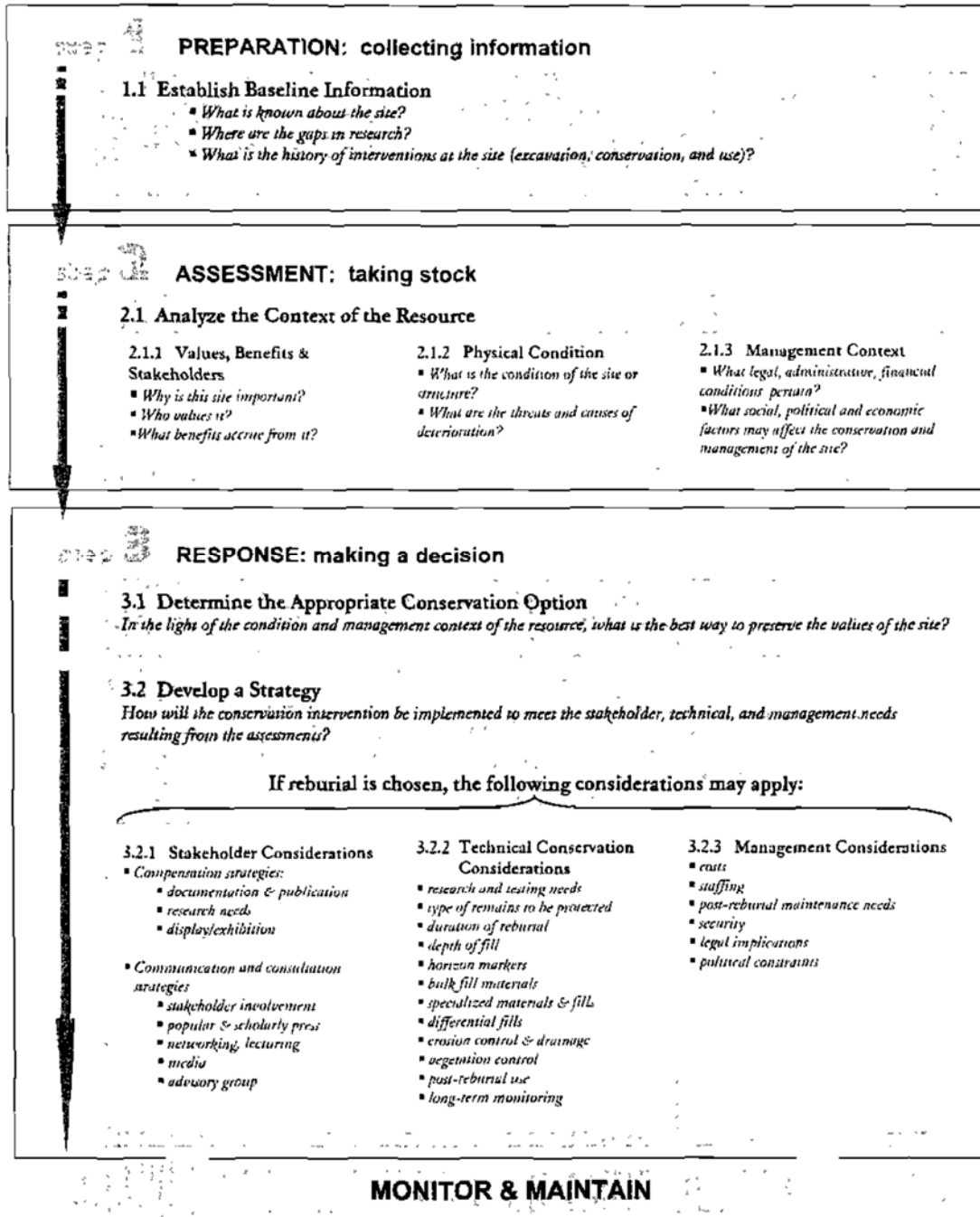

Figure 4.2 Decision making process for reburial of archaeological sites (from Demas 2004)



Bilsbarrow (2004) wrote a guidance point to detail the official position of the SHPO (State Historic Preservation Office) and to present some resources for archaeologists wishing to engage in this conservation practice. The document compiles some of the existing resources for the design of reburial systems, including a short section aimed towards design. However, due to the lack of guidelines, the information presented is rudimentary. Bilsbarrow makes the point *that “most burial-in-place studies occur as ‘gray literature’ that is unpublished contract reports or papers typically only available from the sponsoring agency”*. The document recommends using Mathewson’s artifact decay matrix for guidance on reburial system design. Bilsbarrow also states that reburial systems should address the factors and guidelines for evaluating reburial systems presented in Figure 4.3.

Hester (1988) performed both laboratory and field experiments to determine the behavior of buried archaeological remains. He started by performing compression and chemical tests on archaeological material in the laboratory, and followed it by constructing two simulated archaeological sites under 40 to 75 foot tall embankments. The sites were re-excavated after 2 years, and the excavated artifacts were compared to their original condition and position.

Hester found that reburial archaeological material will suffer minimal physical damage even when deeply buried. He recommends that reburial be undertaken when the following conditions are met:

- I. Burial-in-place will Preserve an archaeological site's contributing elements and important data values (i.e., Register-qualifying characteristics) situated within the treated area.**
- It should maintain as close as possible the existing natural rate of decay of important site elements, features, deposits, or artifacts.
  - It should avoid introducing new impacts to the site and any adjacent historic properties (e.g., compaction, water percolation, leaching).
  - It should reduce existing impacts to the site in number, frequency, or magnitude.
  - It should be reversible.
  - Introduced materials should be clearly distinguishable from existing features, deposits, and artifacts (e.g., non-degradable fabric or culturally sterile, non-local material).
- II. The site or portion of thereof subjected to burial-in-place will be Protected in perpetuity.**
- The land manager or owner and its successors should commit to a legally binding agreement in perpetuity (e.g., an easement).
  - The protective structure should be periodically monitored to assess the treatment's effectiveness and verify the archaeological site's integrity.
  - Planned and subsequent land-use activities should be compatible with the protection of the buried site and should not introduce new impacts (e.g., fertilizer-related leaching).
  - The site should be protected from vandalism and inadvertent damage (e.g., construction activities, monitoring, vegetative screening).
  - The site or portion thereof subjected to burial-in-place must be accessible for future research.
- III. The Research Value of a site considered for burial-in-place must be assessed prior to treatment.**
- The site should only be listed or eligible for inclusion in the State or National Registers of Historic Places under Criterion D (Information Potential); if other eligibility criteria apply, burial-in-place is probably not an appropriate treatment.
  - The site should have little actual or potential public interpretation or traditional cultural use.
  - The site's information content and condition should be adequately known in order to make informed decisions regarding treatment; archaeological excavations should be conducted only to extent needed to make these decisions (e.g., eligibility testing, determine location & depth of cultural deposits within the site).
  - The site's information value, when considered in terms of current applicable historic contexts, anthropological and archaeological theories, cultural history knowledge, and archaeological techniques, should be justifiably determined either temporarily redundant or not immediately relevant to current research questions and themes.
  - The site's information content should be reasonably expected to address research questions and themes likely deemed important in the future.
- IV. Preserving the site or portion thereof through burial-in-place should be more Cost-Effective than conducting data recovery excavations or implementing other options.**
- Burial-in-place treatment costs, both short-term (e.g., design & construction of a protective structure) and long-term (e.g., monitoring & maintenance in perpetuity), should be estimated and compared to cost estimates of other options.
  - A funding source (e.g., endowment; agreeable entity) should be identified to pay for monitoring, annual report preparation, and continual maintenance of the protective structure.

Figure 4.3 Factors and guidelines for evaluating reburial systems (from Bilsbarrow 2004)

a.) Sufficient information about a sites content, location, and significance is gathered to make an informed decision

b.) Protective fill type is selected to minimize chemical contamination

c.) Fill placement is conducted in such a manner as to minimize damage to surface or near-surface artifacts and cultural deposits, and

d.) a means for future access to buried, particularly deeply buried archaeological deposits is included in the reburial system.

Mathewson et al. (1992) offer instead the following recommendations for ensuring the success of a reburial system in protecting the archaeological material:

a.) The protective fill [i.e. the reburial system] should not increase the vertical load on the archaeological site. If the site occurs in a compressible soil type, a rigid cover should be used to dissipate the added stress. Otherwise, artifacts may be damaged, displaced, or both.

b.) The protective fill should create chemical and micro environmental conditions that closely match that of the archaeological deposit. A limited difference in pH may be acceptable since the relatively high organic fraction of most archaeological deposits can act as a buffer.

c.) The protective fill should not increase the frequency or magnitude of existing cyclic changes in the moisture content within archaeological deposits, In general, increases in the moisture content damage archaeological deposits and should be avoided, unless completely wet anaerobic conditions (i.e., total inundation) can be achieved.

Mathewson's greatest contribution to reburial system design is his artifact decay matrix (Figure 4.5), that qualifies the impact of several conditions on the survival of archaeological material. The use of this matrix for design is recommended (Bilsbarrow 2004; Thorne 1991a), and Bilsbarrow recognizes it as the most complete design guide

available for reburial systems. Mathewson also included a qualitative assessment of the severity of physical processes for the conservation of archaeological material, presented in Figure 4.4

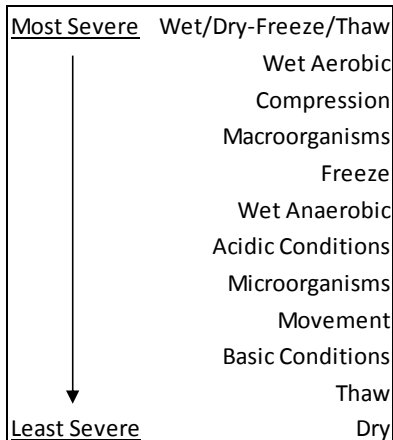

Figure 4.4 Qualitative assessment of severity of conditions for the protection of buried archaeological material (Mathewson and Gonzalez 1988).

Thorne (1991b) instead focuses on the technical requirements and goals of a reburial project. He states that “*the objective of this technical brief is to provide guidance in design of an effective project for intentional site burial*”. Thorne gives an outline for an effective reburial project, consisting of:

**a.) Evaluate the components of the site:** Since the decision to engage in in-situ conservation will be taken after a site has been studied, the archaeological components of the site will be known at the start of the project. The array of artifacts and features which are in the site must be considered in the conservation process, as each material has different preservation requirements (see Figure 4.5).

E=ENHANCES PRESERVATION A=ACCELERATES DECAY N=NEUTRAL OR NO EFFECT	ANIMAL BONES	SHELL	PLANTS	CHARCOAL	CRYSTALLINE LITHICS	GRANULAR LITHICS	CERAMICS	ARCHAEO. FEATURES	SOIL ATTRIBUTES	METALS	CONTEXT	ISOTOPE CONTENT	TOPOGRAPHY
ACID ENVIRONMENT	A	A	E	N	N	A	N	N	A	A	N	A	N
BASIC ENVIRONMENT	E	E	A	N	N	E	N	N	A	A	N	N	N
DRY (CONT.)	E	E	E	E	N	E	N	N	N	E	N	E	N
WET ANAEROBIC (CONT.)	E	E	E	A	A	A	A	A	A	A	N	A	A
COMPRESSION	A	A	A	A	N	N	A	A	A	N	A	N	A
MOVEMENT	N	N	N	A	N	N	N	A	A	N	A	N	A
WET-DRY	A	A	A	A	A	A	A	A	A	A	N	A	A
MICROORGANISMS	A	N	A	A	N	N	N	N	N	A	A	A	N
MACROORGANISMS	A	A	A	A	A	A	N	A	A	N	A	N	N
WET AEROBIC	A	A	A	A	A	A	A	A	A	A	N	A	N
FREEZE-THAW	A	A	A	A	A	A	A	A	A	N	A	A	A
FREEZE	A	A	A	A	A	A	A	N	E	N	A	E	N
THAW	N	N	N	N	A	A	N	N	A	N	A	A	N

Figure 4.5 Effect of soil characteristics on the decay rate of various archaeological materials (from Mathewson 1988).

Besides information from the archaeological components, it is also necessary to characterize the conditions at the site. This information may not have been collected as part of a normal archaeological investigation and includes such parameters as soil pH, water table locations, reduction-oxidation processes happening at the site, chemical properties of the water present at the site and soil samples. This data from the natural soil conditions will help determine what degradation processes have been present at the site and may be expected in the future and should guide the design process for a reburial cover. It is

necessary to ensure chemical and organic compatibility of natural and fill soil, in order to prevent further damage to the archaeological material.

**b.) Measure potential impacts, including decay processes against the goals for protecting the site:** In a conservation in-situ scheme, it is important to ensure maximum protection for the reburial cover while minimizing negative effects that the cover may have. Thorne calls for a multidisciplinary team to determine the optimum design, and he states that each team should include an archaeologist, a geologist and an engineer.

Thorne discusses the responsibilities of each team member, while pointedly stating that their work should be integrated and not as a series of independent steps. He places the burden of cataloguing the archaeological material and prioritizing conservation efforts on the archaeologist. Because there is no soil condition that will enhance conservation of every archaeological material (see Figure 4.5), this means that certain classes of archaeological material may be unprotected or lost. The geologist should understand the decay processes of the archaeological material which has been prioritized, and prescribe a fill material which will enhance the preservation of the archaeological remains and be compatible with the natural soil. The engineer is charged with the design of the cover. He should arrange for the desired fill material acquisition and placement, whilst keeping in mind the hydraulic properties and chemical properties of the fill and their effect on the archaeological remains. The engineer should also be responsible for the reburial cover placement and ensure that the overburden of the reburial cover and the construction activities will not damage the archaeological material. Thorne states that differing ideas about the reburial design should be discussed by the team, in order to arrive at a consensus when all three parties involved are satisfied. If any external restrictions are applied to the project (such as compliance to

construction standards) then those should be followed, even if it means the archaeologist must yield in certain demands.

**c.) Assess the benefits of intentional site burial:** Thorne states that *“the difficulties of covering a site are more apparent than real and can be overcome through a stabilization program that is designed with care”*. He proposes that reburial will protect a site from damage due to cultural and natural processes. Thorne states that the site will be protected from cultural processes such as vandalism and looting, which will be very difficult if not impossible. He states that protection from construction activities is the most direct benefit from reburial if the multidisciplinary team included that as part of their conservation goals. Reburial also protects the site from natural processes as rainfall, strong winds and surface erosion. Damage from frost/thaw cycles can also be eliminated if the fill depth exceeds the depth of the frost line.

**d.) Specify the methods and procedures to be used in the project, including cost considerations:** Before placing the reburial cover on the site, it must be marked and documented so that it may be relocated in the future. This includes the establishment of horizon markers in the reburial system and benchmarks and references on top of the cover. If construction is expected to take place at the site, these references should be placed in such a way to accommodate the construction activities. Presently, GPS coordinates can prove invaluable in documenting a site’s location. The process of placing the reburial cover should be designed so that it doesn’t cause compression or warping of the site’s contents or stratigraphy. Thorne recommends placing a thick first layer of fill and to use tracked equipment in order to alleviate this issue. Vibrations from compaction equipment must also be accounted for. In order to ensure continued protection of the remains, and to inform

future projects, monitoring equipment should be placed at the site. Lastly, budgetary concerns should be taken care of by not only planning for material and overhead costs during the design and construction phases, but also planning for monitoring costs of the site.

From the literature, common themes describing a successful reburial cover can be glanced.

The recurring elements for a successful reburial scheme are:

**a.) Determining the archaeological material present and the decay processes which**

**affect it:** Because of the ample of variety of archaeological sites, their contents can be very different from one site to the other. We can group archaeological material in large classes which will decay similarly (see Figure 4.5). It is important to understand what type of archaeological material is present at the site and how that material decays in order to produce the environment which is most beneficial for preservation.

**b.) Understanding the site's environmental conditions and engineering properties:**

As there is variability in the archaeological material, there is also variability in the soil environment at the site. It is important to characterize the natural soil and the fill soil (if used) and how those properties will affect the decay processes of the archaeological material. Thorough investigation of soil and water chemical properties may be necessary, as well as determining the soil's physical properties.

**c.) Having a foreknowledge of the demands which will be placed on the site:**

The future use of the site will greatly impact the cover design. Overlying construction, frequent soil permeation or nearby vibration sources can impact archaeological material conservation



and should be accounted when designing the cover. Often, it will be necessary to install a more complex and expensive reburial system if the site will be used.

**d.) Having a multidisciplinary team involved in the design and installation process:**

It is necessary to have a multidisciplinary team for a successful reburial system. The archaeologist must determine, and if necessary prioritize, the array of archaeological material present and the preservation necessities of that material. These are tasks for which an engineer is not trained. Salvadori (1976) says that *“it is felt by most concerned scientists that most of the destructive action attributable to engineers is due to ignorance”*. Conversely, it is necessary that the reburial cover be designed and implemented by a trained professional in order to avoid further damaging the site. Kavazanjian (2004) mentions that in archaeological site reburial *“many of these applications have been ad hoc solutions rather than engineered applications, sometimes resulting in ineffective or less than optimal performance, unnecessary cost and, at times, even counter-productive (damaging) field performance”*. Sidell et al. (2004) state that *“those making the decisions whether to preserve or excavate tend to be individuals lacking the technical expertise to predict how a site will respond under the scenarios presented for a site’s future”*. It is indispensable to include someone with that expertise in the design and installation processes.

**e.) Monitoring the site after reburial:** Continued monitoring of the archaeological site is necessary to qualify the effectiveness of the reburial and to ensure the continued preservation of the archaeological remains. Monitoring should be accommodated in the design process (by installing sampling wells for example) and in the budget.

#### 4.4 Basis for the DAISEE method of reburial system design

The DAISEE design method was born of the desire to have a standard method for design of reburial systems, which would take archaeological knowledge and practice about preservation of historical materials and integrate geotechnical engineering knowledge and techniques to provide a technical and quantitative basis for design.

This design is partly inspired by the construction of landfills. Landfills, like reburial systems, also seek to create and maintain a favorable environment for the material buried and to isolate it as much as possible. In both cases, groundwater levels and chemistry must be carefully managed in order to meet performance standards. Many suggested procedures for design of layers in a reburial system are analogous to the design of layers for a landfill. Other design recommendations were based on pavement design.

Where case histories have proved certain solutions to be effective for specific site conditions, those same solutions are recommended. Because of the proven uses of geosynthetic materials in archaeological reburial systems, these materials are often recommended. Kavazanjian (2004) provides an excellent summary of the possible uses for geosynthetics in reburial systems.

The work by Mathewson (Mathewson and Gonzalez 1988; Mathewson 1989a; Mathewson et al. 1992), especially his site decay matrix was the principal influence of this design method. The DAISEE method started with a desire to quantify the information in that matrix in order to use it for design purposes.

## 4.5 Decay processes of archaeological material

### 4.5.1 Site decay processes

One of the challenges in using an engineering design method for reburial systems is the assessment of the conservation state of the archaeological material present. Although a trained archaeologist can easily make a qualitative assessment of the condition of the material, there needs to be a way to transform that qualitative assessment into a quantitative input for a design process.

However, the variability inherent in archaeological material makes the characterization of a site difficult. Besides the variability in types of archaeological material (pottery, metal artifacts, etc...), there is also variability within each category. The mechanical properties of pottery, for example, vary greatly due to the materials and process used to manufacture it. A low fired pottery artifact will usually be much less dense than a high fired pottery artifact. This will result in the strength of each material being very different, as high-fired pottery will typically be a lot stronger than low-fired pottery. Because most archaeological material found on sites dates from before mass production was common, even similar artifacts found at the same site may have very different characteristics.

However, although the specific properties for each material can vary greatly, the decay processes for each type of material remain consistent. Mathewson (1989c) introduced the concept of a site decay model, in order to try to characterize the succession of external factors which can impact the preservation of a site. He patterned his model after a forest succession model, which is also impacted by seasonal factors (e.g. climate change), and specific events (e.g. a fire). Figure 4.6 shows the process-time relationships for both a

forest, and for an archaeological site. In Figures 4.6.A and 4.6.D, the independent variables for both forest development and site decay are uniform through time, and so a smooth succession curve is seen. Once equilibrium is reached, there must be a change in the independent variables for the conditions to change.

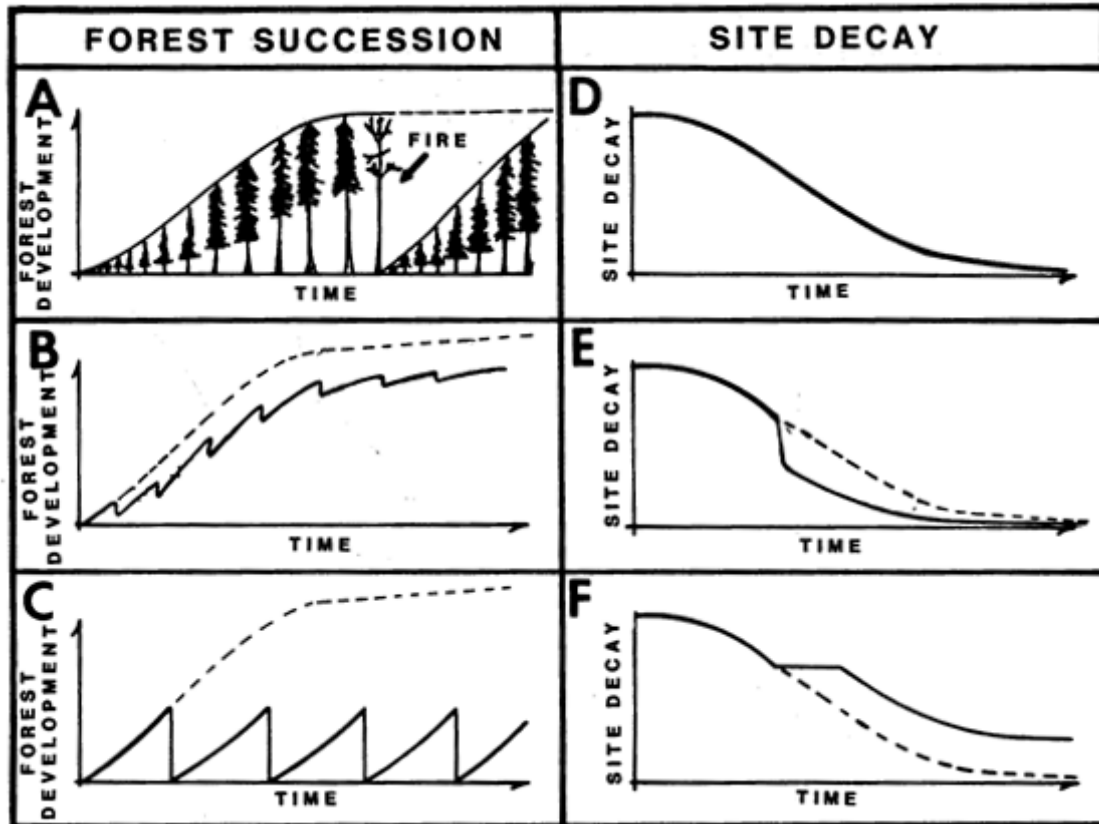

Figure 4.6 Schematic process-time relationships for forest succession and archaeological site decay. In (A) and (D), the independent variables are uniform and the process-time relationship follows a smooth curve. A significant external, independent variable, fire in (A) causes an abrupt step function change in the process-time relationship. Non-uniform or cyclic changes in the value of the independent variables cause irregular process-time relationships. Changes can increase decay (E) or that retard decay (F) (from Mathewson 1989a).

Figure 4.6.A shows a forest fire, after which the forest development is stopped. If this change is cyclical, equilibrium may eventually be reached after setbacks (Figure 4.6.B), or it may prevent equilibrium to be ever reached (Figure 4.6.C). On an archaeological site,

the changes which alter or prevent equilibrium are commonly brought about by construction activities, and will accelerate site decay (Figure 4.6.E). However, unlike forests, archaeological sites are non-renewable resources and each change that affects the equilibrium of the site causes irreparable damage to the archaeological material. The goal of any conservation option, including reburial, is to retard site decay (Figure 4.6.F) as much as possible.

Because there are a myriad of factors which may impact a site, Mathewson proposed that these factors be researched in a multi-disciplinary team so that *“the interactions between each of the independent factors can be combined to develop a single [site decay] model”*. He expected the general time-decay relationship to take the form of a factorial equation similar to the one below:

$$SD = f(Aa\alpha + Bb\beta + Cc\gamma) + g(Dd\delta + Ee\epsilon + Hh\mu) + \dots$$

In which, SD = site decay rate; f and g are interaction functions; A,B,C,D, ... are constants; a,b,c,d, ... are independent variables derived from the study of each factor; and  $\alpha, \beta, \gamma, \delta, \dots$  are exponents established by the time relationship of each independent variable.

Although this was an ambitious project, it was never completed. However, it served as a starting point for the site decay matrix. This matrix allows us to identify broad conditions which are deleterious to the conservation of the archaeological material and to determine the desired conditions for the optimum preservation of the archaeological material. Although Mathewson's matrix doesn't quantify the effect of various burial environments on the decay process of artifacts, it provides a valuable starting point for this endeavor.

#### 4.5.2 Site sensitivity equation

Although the site decay rate equation would be useful for an evaluation of where the site stands in the decay process, and whether intervention is necessary, it does not provide enough information to be used as input in a design process. While it takes into account the processes which work against the conservation of a site, it groups them together to take a holistic view of the site. An approach which quantifies the threats against the survival of a site for each specific source of damage would be more indicative of the needs that must be met by the conservation option chosen. Furthermore, the design inputs used would not only have to take into account the damage which has already taken place at the site, but also the potential damage which may occur. Because of this, the authors would like to propose the use of a “sensitivity equation”. This equation, which would take the same form regardless of the source of damage, would seek to quantify the sensitivity of an archaeological site (or an artifact assemblage) to a specific deleterious condition. After a sensitivity factor is computed for each damaging factor, these can then be used as guidance for a reburial system design.

This sensitivity equation would take the following form, for an assemblage with n different types of archaeological material:

$$S_x = \text{Sensitivity factor to condition 'x'} = \sum_{i=1}^n D_{x_i} * \bar{C}_i * P_i$$

Where  $D_x$  is the damage coefficient for that particular archaeological material for the specified condition,  $\bar{C}_i$  is the average coefficient of degradation for that specific

archaeological material, and  $P_i$  is the percentage of that archaeological material in the total assemblage (in decimal form).

The damage factor is representative of how that particular condition affects the archaeological material. It is between 0 and 1, with 0 meaning that the condition does not affect the material (e.g. a chemically inert material in an acidic environment) and 1 meaning that the material is extremely damaged by that environment (e.g. bone in an acidic environment). Table 4.2 shows proposed values for the most common archaeological material found in sites, and common deleterious environments. This table was partially based on Mathewson's, and reflects a desire to quantify the information presented there. Although it is a much abridged version, future work will focus on expanding it to cover all the conditions and archaeological material presented in Mathewson's matrix.

Table 4.2 Proposed values for damage coefficients

	GLASS	CERAMICS	ANIMAL BONES	METALS	WOOD
LOAD	1	1	0.8	0.1	0.3
ACID ENVIRONMENT	0	0	1	0.6	0.5
OXIDIZING ENVIRONMENT	0	0	0.8	1	0.2
WET AEROBIC	0	0	0.8	0	1

The coefficients in Table 4.2 are proposed based on experimental data. Samples of each archaeological material were placed in the damaging environment and then analyzed to see the damage that had occurred. Because of the great amount of variability in archaeological material, the values presented here are meant as guidance and should be evaluated in the

context of the specific site to be reburied. For example, although modern, industrially manufactured glass is chemically inert and safe from pH and reduction-oxidation related damage, older glass artifacts can be susceptible to chemically related decay processes.

The average coefficient of degradation is computed differently depending on the archaeological material. It's meant to represent the state of the archaeological material at the time and also the potential damage which has yet to occur. For osseous material, metals, and wood the average coefficient of degradation is computed as:

$$\bar{C}_i = C_i = \frac{1}{\frac{M_d}{M_o}}$$

Where  $M_d$  is the current (degraded) mass of the archaeological material, and  $M_o$  is the original mass. Because in practical cases, these values are either difficult or impossible to obtain, the ratio of current to original mass should be estimated by a trained professional, ideally an archaeologist. This formula should only be applied to materials that have lost 75 % of their original mass as a maximum. For archaeological material which is in a more advanced state of deterioration, the floor value of 25 % for the ratio of  $M_d/M_o$  should be used. However, as this material would be severely degraded and may not present much scholarly value the archaeologist responsible may decide not to account for it in the reburial design in order to emphasize the survival of better preserved archaeological material.

For materials like glass and ceramic, the coefficient of degradation is computed by averaging the shape coefficients (presented in Table 4.3) of the individual assemblage pieces. A large flat piece is defined as being larger than 15 cm at its largest point, whereas a large concave piece is defined as having parallel elements separated by more than 10 cm.



Table 4.3 Proposed shape coefficients for glass and ceramic.

Object	Shape Coefficient
Shard	1
Small flat	1.5
Large flat	2.5
Small concave	3
Large concave	4

Table 4.4 Description of site sensitivity ranges

Site Sensitivity	Description	Monitoring
$0 \leq S_x < 1$	The material is either not sensitive, or has a very low sensitivity to this condition. There is a low risk of deterioration.	Recommended, but not necessary
$1 \leq S_x < 2$	The material is somewhat sensitive to this condition. The potential damage to the archaeological assemblage will be determined by the specific site conditions (e.g. the magnitude of the load applied to the site). Measures to prevent damage should be designed into the reburial system.	Recommended
$2 \leq S_x < 3$	The material is sensitive to this condition. When designing the reburial system, care must be taken to prevent the archaeological material from being damaged. Extraordinary measures specifically designed to protect the archaeological material from this cause of damage should be considered.	Necessary
$3 \leq S_x \leq 4$	The material is extremely sensitive to this damage source. Extreme care should be taken to prevent damage to the archaeological material, and any measures available should be taken and incorporated into the reburial system	Critical

The possible range of values for site sensitivity is between 0 and 4. A higher value means that the archaeological material present at the site is more likely to be damaged by that specific condition. This may be due because the material is very sensitive to that condition, because there is a large quantity of material sensitive to that condition, because the material

which is sensitive has already begun the decay process, or a combination of these factors. Table 4.4 gives a brief description of site sensitivity ranges.

### **4.5.3 Calculation of Sensitivity Factors based on Literature**

Based on the reburial systems available from the literature, sensitivity factors were attempted to be computed for previous projects. However, the available literature did not present the necessary information for the factors to be calculated. In most cases there was only a cursory description of the archaeological assemblage to be preserved, and when more than one material type was present there was no description of the assemblage composition. The information on the condition of the material was also lacking, as it was only given in descriptive terms. A summary of the case histories with the most information from the selected reburial projects is given in Table 4.5.

The reason for the lack of information is two-fold. First, the literature which is widely available consists in a large majority of published journal articles and conference proceedings, in which the focus was not on describing the finds, but on describing the conservation process. This information is more likely to be published internally, in site reports which are difficult to access. Second, the information required is difficult to accurately obtain. Only a complete excavation of the site can yield a detailed summary of the archaeological assemblage, and although cataloguing shard shapes and sizes, the ratio of mass lost to original mass can only be estimated. In most cases, both the archaeological assemblage composition and its state will need to be estimated from the available site information.

Table 4.5 Summary of available information for computing of sensitivity factors from the literature

Project	Wood	Bone	Glass	Ceramic	Metal	Publications	Condition
Guildhall Yard	100%	0%	0%	0%	0%	Goodburn-Brown and Hughes 1996	No condition given
Bramcote Grove	100%	0%	0%	0%	0%	Goodburn-Brown and Hughes 1996; Johnsen 2009; Nixon 1998	Wood was slightly degraded
Burial Ground	50%	50%	0%	0%	0%	Tilly 1998	No condition given, assemblage composition estimated
Second Shardlow Boat	100%	0%	0%	0%	0%	Williams et al. 2008	Mostly intact
The Rose Theatre	100%	0%	0%	0%	0%	Corfield 2004; Wainwright 1989	Very well preserved
Park Lane	20%	20%	20%	20%	20%	Goodburn-Brown and Panter 2004	No condition given, assemblage composition estimated
Nedre Baklandet 56	100%	0%	0%	0%	0%	Johnsen 2009	Damaged by earlier construction

In order to refine the site sensitivity equation, it is necessary to evaluate its use in a variety of situations. Case histories can provide an excellent opportunity, as typically there are large amounts of data available. As reburial system design processes are refined, it will be necessary to establish publishing guidelines that provide information to support design, such as detailed assemblage composition and state. This information is crucial to the development of reburial system design, even if the values are estimated based on site knowledge.

#### 4.5.4 Prioritized Site Sensitivity Equation

In certain cases, it may be necessary to focus on the preservation of a particular type of archaeological material in the assemblage. This may be because a fraction of the assemblage may be much rarer than the rest, or be crucial to the understanding of the site. In these cases, the prioritized site sensitivity equation can be used to reflect the increased focus on the preservation of that particular material in the assemblage. The prioritized sensitivity equation was designed to allow for the quantification of intangible archaeological parameters. However, it must be noted that oftentimes, designing a burial

environment which is meant to maximize protection of one type of archaeological material can accelerate decay in others. The archaeological expert must be aware of the consequences of changing the burial environment on the conservation of the assemblage as a whole.

To compute the prioritized sensitivity factors ( $S'$ ), the following equation can be used:

$$S'_x = \text{Prioritized sensitivity factor to condition 'x'}$$

$$= \left( \sum_{i=1}^n (D_{x_i} * \bar{C}_i * P_i) \right) + \sum_{i=1}^n D_{x_i} * T_i$$

Where  $\sum_{i=1}^n T_i$ , the overall prioritization is the sum of the prioritization factors "T" for all the materials for condition 'x'. The prioritization factor for individual materials is a function of both the material present in the assemblage, and of the value placed on those materials by the archaeologist. As the prioritized equation is used to allow for the participation of parameters which can be hard to quantify (research value, cultural and aesthetic value, rareness, etc...), it is designed to be able to be heavily skewed by the "archaeological value" component.

Although the prioritized site sensitivity equation can give added importance to the preservation of a particular subset of the assemblage, it is still dependent on other factors. Both the percentage and condition of the assemblage subset that is being prioritized play a large role in the computation of the overall prioritization factor, so this equation may not be appropriate for sites where the conservation of a very small fraction of the assemblage is paramount. Both the condition of the material at the time of reburial and the susceptibility for damage of that material due to a specific condition play important roles in the

determination of the prioritized sensitivity factor for that assemblage for a given condition. This equation serves to augment the site sensitivity factor for design guidance, as such care must be employed when analyzing the output. If the prioritized site sensitivity factors are computed and used for guidance in the DAISEE method, these should be used throughout the entire process. Prioritized and un-prioritized factors should not be mixed in the same design.

To compute the prioritization factor of a material to a specific condition ( $T_i$ ), the following equation may be used:

$$T_i = A_i * \psi_i$$

Where  $A_i$  is the archaeological value factor (see Table 4.6), and  $\psi_i$  is the material factor, which can be obtained from Figure 4.7. The selection of the appropriate archaeological value factor should be performed by a qualified archaeologist after the evaluation of the archaeological assemblage. Because archaeological value is a subjective measurement, some variability can be expected in the computation of prioritized sensitivity factors by different archaeologists.

Table 4.6 Different archaeological value factors for the computation of prioritized sensitivity factors

Archaeological value	$A_i$
This material has the same value as all others	0
This material has a slightly higher value than all others	1
This material has a higher value than all others	2
This material has a much higher value than all others	3

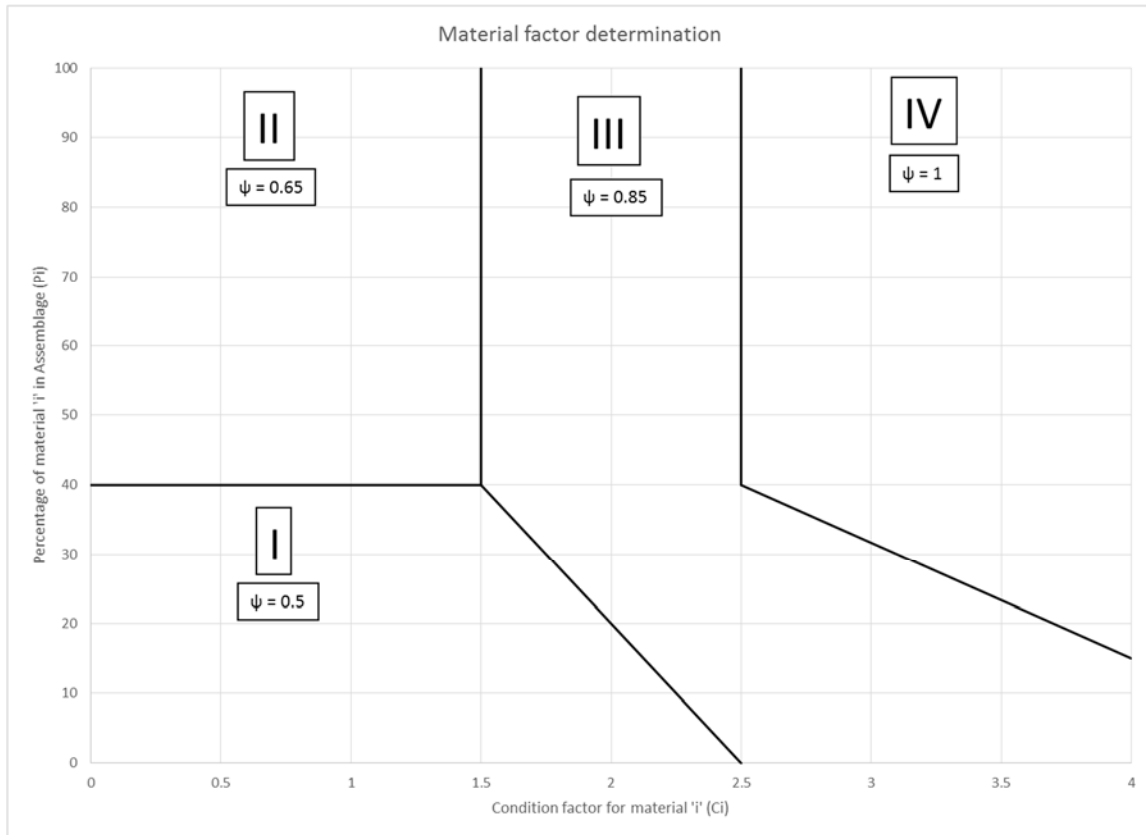

Figure 4.7 Determination of the material factor for the computation of prioritized sensitivity factors

The material factor ( $\psi_i$ ) can be obtained from Figure 4.7 and is meant to reflect the status of that material in the archaeological assemblage. It is dependent on both the quantity of material present in the assemblage relative to the total material, and in the state of that material. Zone I includes is for material which is in good condition, and scarce in the assemblage. Because these materials are well preserved and a minority, it is not necessary for a high prioritization. Zone II is for materials which are abundant in the assemblage, and in good condition. Although they are still well preserved, the material factor is higher due to their increased presence in the assemblage. In zone III are materials which are scarce in the assemblage, yet have suffered some damage. Zone IV has materials which are both

abundant and damaged. Because these last two cases have material which has begun the decay process, the material factor values are the highest.

#### 4.5.5 Environmental and mechanical numbers

The environmental number ( $N_E$ ) and mechanical number ( $N_M$ ) seek to quantify the likelihood of damage from environmental or mechanical sources. As this is a function of both site conditions, and archaeological material, both of these need to be accounted for in the formula. Based on which number is higher, the reburial system will be classified as either mechanical or environmental.

**Environmental number:** The environmental number seeks to quantify the likelihood of environmental damage to the archaeological material, by taking into account both the expected inflow rate to the archaeological layer at the site, and the sensitivity of the artifact assemblage to damage from physico-chemical-biological processes which are the main mechanism of decay for wet archaeological material. The effect of the site conditions on the archaeological layer is computed by calculating the ratio of expected inflow rate to the archaeological layer over inflow to the archaeological layer pre-burial ( $R_{post}/R_{pre}$ ). The sensitivity of the assemblage is quantified by averaging the sensitivity factors of the assemblage to damage due to changes in pH, reduction-oxidation processes, and microbial activity.

$$N_E = \frac{R_{post}}{R_{pre}} * \left( \frac{S_{pH} + S_{redox} + S_{O_2}}{3} \right)$$

Where  $R_{post}$  is the expected inflow rate to the archaeological layer post-burial,  $R_{pre}$  is the inflow rate to the archaeological layer pre-burial, and  $S_{pH}$ ,  $S_{redox}$ , and  $S_{O_2}$  are the computed sensitivity factors for pH, redox potential and dissolved oxygen respectively. If conservation of a subset of the assemblage is favored, the prioritized sensitivity factors may be used. The higher  $N_E$  is, the more protection against environmental sources of damage is needed.

**Mechanical number:** The mechanical number seeks to quantify the likelihood of mechanical damage to the archaeological material. It takes into account the stresses felt by the archaeological layer (for example due to overlying construction), and the sensitivity of the archaeological assemblage to load. The mechanical number ( $N_M$ ) is defined as:

$$N_M = \frac{\sigma'_{post}}{\sigma_{ref}} * S_L$$

Where:  $\sigma'_{post}$  is the effective stress at the top of the archaeological layer post-reburial, and  $\sigma_{ref}$  is a reference stress. The value of the reference stress is a function of the maximum past pressure on top of the archaeological layer, the stress on top of the archaeological layer pre-reburial, and the maximum stress that the archaeological material can bear without damage. However, more research is needed to evaluate a suitable way to determine the reference stress.



## 4.6 Design Methodology

### 4.6.1 “Standard” Reburial System

Commonly, reburial systems are installed to protect the archaeological material from a small set of deleterious conditions. Changes in groundwater chemistry (pH, redox potential, and dissolved oxygen) are the most common factor in chemical degradation of the material, while applied load and ground movements are commonly the controlling factors for mechanical damage.

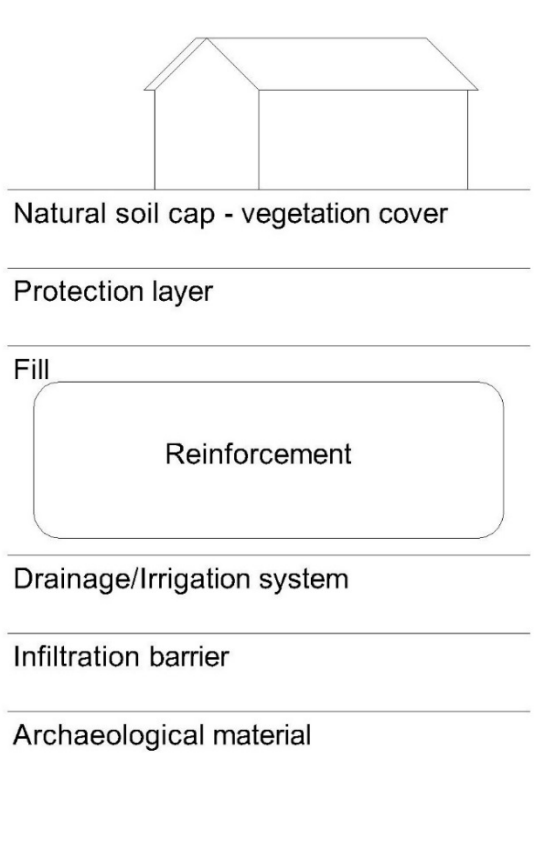

Figure 4.8 Model of a “standard” reburial system

However, although the performance expectation of reburial systems are similar, reburial systems can look very differently. Because reburial systems are usually site specific (with

the exception of “common practice” approaches which usually only cover the archaeological material with a geotextile and then place fill on top) there is no standard reburial system.

In order to facilitate reburial practice, a new design methodology for reburial systems is needed. The DAISEE method works by designing reburial systems with a layer by layer approach. The design starts with a “standard reburial system”, seen in Figure 4.8, and the specific layers are modified, or even eliminated, to suit the conservation needs of the archaeological site as dictated by the archaeological material or the conditions at the site.

Reburial systems are designed to meet many functions, but the principal ones are: filtration, separation, reinforcement, protection, infiltration barrier, and drainage and irrigation. Kavazanjian (2004) presents a summary of the functions that can be performed by different geosynthetic materials in a reburial system (Figure 4.9), and with the exception of irrigation all needed functions in a reburial system can be performed by geosynthetic materials. Kavazanjian identifies geotextiles as the most versatile geosynthetic for reburial systems, as it can perform all of the necessary functions. This can also be seen in the reburial systems which have been implemented, as geotextiles are the most commonly used geosynthetic in practice.

Function	Product						
	Geotextile	Geomembrane	Geo-grid	Geosynthetic clay liner	geo-composite	Geocell	Erosion control product
Separation	X					X	X
Reinforcement	X		X			X	
Filtration	X						
Drainage	X				X		
Infiltration barrier	X	X		X			
Protection	X			X			

Figure 4.9 Functions of common geosynthetic materials (Kavazanjian 2004, from Bouazza 2002)

Because many of these functions can be performed by the same material, reburial systems where the archaeological material is not subject to a damaging environment can have a very simple design. Common practice designs then can be seen as a “bare minimum” design. However, in sites where protection against a specific source of damage is needed, the design can incorporate elements in order to prevent decay of the archaeological material. Certain materials (such as geotextiles) can perform multiple functions.

The DAISEE guidelines assume a level archaeological layer. The reburial system comprises the elements from the top of the archaeological layer, to either the construction surface or the ground surface.

#### **4.6.2 Components of a standard reburial system**

##### **4.6.2.1 Infiltration layer**

The infiltration of groundwater into the archaeological material layer is often the main cause of decay of sites as the changes in moisture and chemistry introduced in the environment by groundwater are commonly the main factor in chemical, physical, and biological degradation of archaeological material. Because of this, reburial systems’ main focus is often on preventing infiltration from reaching the archaeological material.

The role of an infiltration layer is to prevent the passage of groundwater. To effectively impede the flow of water, the infiltration layer must have a low hydraulic conductivity. This can be achieved by using soils with a high fine content (such as clays), or a manmade material (such as concrete, or an impermeable geosynthetic like a geomembrane).

#### 4.6.2.2 Drainage and irrigation systems

In sites where heavy infiltration into the reburial system is expected, a drainage system may be required to maintain an environment conducive to preservation of the archaeological material. Conversely, certain archaeological material (e.g. saturated wood) needs to be kept at a certain moisture level to prevent decay. Drainage and irrigation systems are used for these purposes.

Because the decision to employ a drainage or irrigation system stems from the need to ensure appropriate drainage or complete saturation of the soil, the decision is highly dependent on the artifact assemblage present at the site. While certain archaeological materials can survive in a variety of moisture conditions (glass, ceramics), others are better conserved in a dry environment (metals, bone). Archaeological wood is especially susceptible to damage due to changes in moisture content. Although it can survive in both a dry and a waterlogged condition, if there is a change in condition (dry wood becoming waterlogged, or vice versa) the material quickly decays.

Archaeological sites which have a large quantity of buried archaeological wood are often excellent candidates for reburial. Oftentimes, the conservation cost of unearthed archaeological wood is prohibitive as it must be stabilized to prevent the acceleration of decay due to a change in environment. This makes in-situ conservation, and especially reburial, an attractive option.

It is important to note that the underground hydrological conditions at the site dictate the level of the water table at the site which will remain constant unless disturbed. Because the location of the water table is often critical in the survival of archaeological material, it is

recommended that it should be allowed to stay at its natural level. Moving the water table through either drainage or irrigation will change the moisture conditions of the affected archaeological material, which may accelerate decay.

#### 4.6.2.3 Reinforcement

Reinforcement is often included in reburial systems in order to improve the bearing capacity of the soil. An improved bearing capacity may be beneficial for the site as it allows the use of shallow foundations, which are much less intrusive than deep foundations. Drilled and driven piles are especially damaging for the archaeological material as they destroy the material in their path, and exert a radius of influence where archaeological material is damaged and archaeological context is lost (English Heritage 2007).

The reinforcement can take a variety of forms. Because fill is the largest component of reburial system by volume, reinforcement will be placed within the fill in most cases. Geosynthetics are often used for reinforcement, specifically geotextiles, geogrids, and geocells. Because of their widespread use in both archaeological and non-archeological projects, geosynthetics are recommended to be used as reinforcement in reburial systems.

#### 4.6.2.4 Fill

Fill is the largest component by weight of a reburial system, and the only component which is present in all terrestrial reburial systems. However, there has not been much research in the role of fill in an archaeological reburial system.

When properly designed and placed, the fill can be used to protect the archaeological material. Both the material used and the placement method can severely impact engineering

properties such as permeability and unit weight, which have direct bearing on the preservation of the archaeological material.

Lastly, fill can be used for reburial of both excavated, and non-excavated sites. Commonly, excavated sites will use fill to raise the reburial system to the surface of the site (e.g. Bristolkvarvalet) while sites with archaeological material near the surface (like the second Shardlow boat) and unexcavated sites will use fill to build a protective mound atop the reburial system.

#### 4.6.2.5 Protection layer

A top layer that protects the reburial system from the events happening at the surface is often needed. The protection layer should then be the topmost layer of the reburial system. This protection layer can be used to prevent damage to the archaeological material, but also to the reburial system itself. Erosion, large burrowing organisms, and root penetration are all common outside factors which can negatively impact the performance of the reburial system and damage the archaeological material if exposed. Thorne (1991) writes that *“if a site is not shielded from the consequences of rainfall, the combined effects of frost heaves, subsequent rainfall and strong winds, deflation of the surface will be continuous [...] An obvious advantage of site burial is that surface erosion of the archaeological matrix is eliminated when a new land surface is produced”*. Thus, even a simple reburial system can greatly enhance the preservation outcome of an archaeological site.

The protection layer should be made of a material that is strong and durable, as it will serve as the first line of defense from the elements and activities happening at the surface which

may damage the reburial system or the archaeological material. Commonly, protection layers are made of concrete, riprap, gravel, or other similar material.

#### 4.6.2.6 Cap and vegetation cover

If the surface of the site is to be left exposed to the environment, some form of erosion protection is needed for the reburial system. Additionally, a cap and vegetation cover can be used to protect the site from vandalism, as it will mask the reburial system, and presents aesthetic benefits.

#### 4.6.2.7 Separation and filtration layers

Oftentimes, it is necessary to include separation markers in an archaeological reburial. This may be due to the necessity of separating the archaeological material from components of the reburial system, or to serve as a marker between different layers. Typically, a geomembrane or plastic sheeting material is used for this purpose. However, as those are impermeable, a geotextile may be better suited if the free passage of water is needed.

Filtration layers can be used to prevent soil migration, or the movements of other small particles through the reburial system. Leakage and hardening of cementitious materials is often a source of damage in archaeological sites where they are used in close quarters to the archaeological material.

#### 4.6.2.8 Monitoring plan

A monitoring plan is a necessary component of a reburial system. Because reburied archaeological sites are out of sight, they can quickly be forgotten. Monitoring of the site is also important to ensure that the reburial system is working as intended, and is meeting both the archaeological and engineering demands placed on it.

Monitoring can be performed in a variety of ways, from semi-regular visual inspections to a complex monitoring system using instrumentation. Oftentimes, the monitoring plan will be constrained by the available funds for the project and the interest in the site. Whenever possible, funds for the continuing monitoring and maintenance of reburial systems should be allocated at the planning stage.

## **4.7 Layer design**

### **4.7.1 Design of Geosynthetics**

Geosynthetics are the second most common element of reburial systems, after fill. Geosynthetics are used for many different applications in reburial systems (Kavazanjian 2004). There is a wide variety of geosynthetics available for a range of applications. Common uses for geosynthetics materials are shown in Figure 4.9. The design of a geosynthetic for a particular function will be affected by the in-situ soil properties, the fill properties, and the geosynthetic properties. For use as separation geosynthetics should have a small enough apparent opening size (AOS) so that the materials they are in contact with (in-situ soil, or fill) are unable to pass through the material. If the geosynthetic is placed in contact with archaeological material, it should be chosen to have minimal adhesion to prevent damage of the archaeological material. For use of the geosynthetic as filtration, the AOS of the geosynthetic should be small enough to prevent the passage of soil particles, while allowing for the free passage of water. Section 4.7.7 discusses separation and filtration functions of geosynthetics in more detail. Drainage can be performed using a geosynthetic, in which case the design will be governed by the allowable flow rate of the geosynthetic. Section 4.7.3.2 discusses the design of a drainage layer. Geosynthetics can



also be used for protection, as some materials (like GCLs) can have a cushioning effect on the archaeological material. The design of a protection layer is discussed in section 4.7.6. Geosynthetics can be used as infiltration barriers. In this case, the hydraulic conductivity of the geosynthetic will govern design. Infiltration barriers are discussed in section 4.7.2. Lastly, geosynthetics can be used to reinforce the fill. This will improve the bearing capacity of the fill, and minimize or eliminate differential settlement under the fill. Section 4.7.4 discusses the use of geosynthetics as reinforcement for reburial systems.

Commonly, the decision to use a particular geosynthetic is made based on the availability of the geosynthetic (Johnsen 2009). However, geosynthetics used in reburial systems should meet not only the archaeological demands placed on them, but also the engineering demands. As geosynthetics are most commonly placed under the fill, near the archaeological layer, they are subjected to stresses due to the weight of the reburial system above them (principally the fill) and any loads applied at the surface. The fill will have a large impact on the selection of an appropriate geosynthetic, as both height and unit weight of the fill are responsible for the load due to the fill weight which is a large portion of the stresses induced on the geosynthetic.

The principal mechanical parameter to select geosynthetic materials is the allowable tensile force on the geosynthetic. The allowable tensile force of a geosynthetic is dependent on both the material properties of the geosynthetic and on the geosynthetic thickness. If a geosynthetic clay liner is selected, the stability of the soil between the carrier geosynthetics also needs to be evaluated.

#### 4.7.1.1 Tensile stresses on geosynthetics

Shear stresses above a geosynthetic act downward on the geosynthetic and mobilize upward shear stresses from the underlying soil underneath the geosynthetic. This can result in the geosynthetic going into a state of pure shear, if the shear stresses above and below are equal, or into the geosynthetic needing to carry some part of the stress in tension, if the stress above the geosynthetic is higher than the stress below it. The latter scenario typically occurs when a material with high interface friction (such as sand or gravel) is above the geosynthetic, and a material with low interface friction is placed below. Because fill materials used in reburial systems can often be granular and have a high interface friction if compacted well, when a geosynthetic is placed between the fill and the archaeological layer, oftentimes it will need to carry some tension.

The factor of safety against tensile failure ( $FS_T$ ) in a geosynthetic is computed as:

$$FS_T = \frac{T_{allow}}{T_{req}}$$

Where  $T_{req}$  is the mobilized tensile force on the geosynthetic, and  $T_{allow}$  is the allowable tensile force in the geosynthetic. The mobilized tensile force in the geosynthetic is the difference between the unit shear at the upper surface ( $S_U$ ) and at the lower surface ( $S_L$ ) of the geosynthetic, and can be computed as:

$$T_{req} = (S_U - S_L)$$

$$T_{req} = [(c_{aU} - c_{aL}) + \gamma_{fill} * H * \cos \beta * (\tan \delta_U - \tan \delta_L)] * L$$

Where  $c_{aU}$  and  $c_{aL}$  are the adhesion between the geosynthetic and the upper and lower soil respectively,  $\gamma_{fill}$  and  $H$  are the unit weight and thickness of the fill material above the geosynthetic,  $\beta$  is the slope angle,  $\delta_U$  and  $\delta_L$  are the interface friction angles between the geosynthetic and the upper and lower soils respectively, and  $L$  is the length of the geosynthetic. In most cases for reburial, the slope angle will be zero since the excavated surface is maintained at a horizontal level and not on a slope. In these cases when  $\beta = 0$ , the mobilized tensile force is maximized since  $\cos \beta = 1$ . The adhesion and interface friction angle between the geosynthetic and the upper soil are dictated by the fill material used. If tensile stresses on the geosynthetic are a concern, a fill material with acceptable adhesion and interface friction with the geosynthetic can be chosen. The unit weight and thickness of the fill material also play a large role in determining the required tensile force for the geosynthetic.

The allowable tensile force on the geosynthetic is dependent on both the properties of the fabric and its thickness. It can be computed as:

$$T_{allow} = \sigma_{allow} * t$$

Where  $\sigma_{allow}$  is the allowable tensile stress in the geosynthetic (determined through testing by the manufacturer) and  $t$  is the thickness of the geosynthetic. When designing a geosynthetic, a fabric which provides an acceptable safety factor to tensile stresses should be chosen.

If there is localized subsidence under the geosynthetic, tensile stresses on the geosynthetic will be induced in the subsidence area. The subsidence area is assumed to be a spheroid of gradually decreasing center point along the symmetrical axis of the deformed geosynthetic.

The presence of an area with a high density of archaeological material (such as a midden deposit) in the archaeological layer may produce localized subsidence areas as those materials will typically be less stiff than the surrounding soil.

The factor of safety against tensile failure due to a localized subsidence ( $FS_{sub}$ ) can be computed as:

$$FS_{sub} = \frac{\sigma_{allow}}{\sigma_{req}}$$

Where  $\sigma_{allow}$  is the allowable strength of the geosynthetic obtained from a three-dimensional axisymmetric tension test, and  $\sigma_{req}$  is the required tensile strength due to the local subsidence. The allowable strength of the geosynthetic is a material property, and it should guide the selection of an appropriate geosynthetic material. The required tensile strength can be computed as:

$$\sigma_{req} = \frac{2 * D * L^2 * \gamma_{fill} * H_{fill}}{3 * t * (D^2 + L^2)}$$

Where D is the depth of subsidence, L is the distance between the symmetric axis and the top edge of the subsidence,  $\gamma_{fill}$  and  $H_{fill}$  are the unit weight and thickness of the fill above the geosynthetic, and t is the geosynthetic thickness.

#### 4.7.1.2 Runout length and anchoring trenches

When geosynthetics are placed on a slope, it is customary to include a horizontal runout at the top of the slope followed by a short drop into an anchor trench. This is so that the geosynthetic is held in place against applied loads. Although most reburial systems are expected to be constructed above level or near-level ground, an inclined surface may be

encountered. Trench dimensions are likely to be constrained by the available space in the reburial system and the construction demands at the site. In order to ensure the appropriate runout length is used, the following equation can be used:

$$T_{allow} = \sigma_{allow} * t = \frac{q_B * L_{RO} * \tan \delta_L + K_0 * (\sigma_v)_{ave} * d_{AT} * (\tan \delta_L + \tan \delta_U)}{\cos \beta - \sin \beta * \tan \delta_L}$$

Where T is the geosynthetic tensile force (dependent on the material and on the thickness of the geosynthetic),  $q_B$  is the cover soil pressure on the runout length,  $L_{RO}$  is the length of the runout,  $\delta_L$  and  $\delta_U$  are the friction angles between the geosynthetic and the lower and upper soil respectively,  $K_0$  is the coefficient of at-rest earth pressure,  $(\sigma_v)_{ave}$  is the average vertical pressure in the anchor trench,  $d_{AT}$  is the anchor trench depth, and  $\beta$  is the slope angle. The cover soil pressure  $q_B$  can be computed as:

$$q_B = \gamma_s * d_{cs}$$

Where  $\gamma_s$  and  $d_{cs}$  are the unit weight and the depth of the cover soil on the runout length. An iterative process, using different anchor trench dimensions, can be used to design a runout length that will be satisfactory.

#### 4.7.1.3 Shear strength of geosynthetic clay liners

Geosynthetic clay liners (GCLs) are often used as infiltration barriers. As they are composed of a low permeability material (commonly Bentonite clay) between two geosynthetics, they can provide an almost impermeable barrier. However, GCLs must be evaluated for stability as hydrated bentonite has a low shear strength. Both internal shear strength and interface shear strength must be analyzed. The location of the potential failure surface is dependent on the normal stress acting on the GCL. For normal stresses up to 14

kPa, the interface between the GCL and the adjacent material will commonly have the lowest shear strength. For higher normal stresses, the failure surface will move into the GCL (Qian et al. 2001). Unreinforced (adhesive bonded) GCLs provide only a low resistance to shear (Qian et al. 2001). For this reason, unreinforced GCLs are not suitable for slopes steeper than 10(H):1(V). For applications where shear stresses are expected to act on the liner, needle punched and stitched GCLs must be used as the carrier geosynthetics are connected by stitched or needle punched fibers which transmit shear stress across the bentonite layer. Because of this, it is necessary to evaluate both the internal and the interface strength of the GCL to ensure the stability of the reburial system.

Although the bentonite in the manufactured GCLs is considered “dry”, water contents may vary between 15 and 30 %. Due to the high suction value (7500 kPa) of bentonite, an equilibrium moisture content of 50 % to 190 % can be reached in 1 to 3 weeks when the liner is placed in contact with the soil (Daniel et al. 1993). This reduces the peak friction angle of the bentonite from 30° to approximately 9° (Shan and Daniel 1991).

Fox et al. (1998) conducted a study of adhesive bonded, stitch bonded, and needle punched GCLs in a large direct shear machine. From the results, he found that the peak shear strength of each liner could be approximated using linear relationships. The peak shear strength of a GCL can be computed as:

$$\tau_p = C + \sigma_n \tan \varphi$$

Where  $\tau_p$  is the peak shear strength of the GCL,  $C$  and  $\varphi$  are constants dependent on the GCL, and  $\sigma_n$  is normal stress. The values of  $C$  and  $\varphi$  are 2.4, 71.6, and 98.2 and 10.2, 4.3, and 32.6 for adhesive bonded, stitch bonded, and needle punched GCLs respectively.

Besides from internal shear failure of the GCL, failure can also happen at the interface between the GCL and its surroundings. For the interfaces between a GCL and a smooth geomembrane (GM), and a GCL and a drainage geocomposite (GN), a linear failure envelope was fitted to the data. The shear strength of the interface can be computed as:

$$\tau = C + \sigma_n \tan \varphi$$

Where  $\tau$  is shear strength,  $\sigma_n$  is the normal stress, and  $C$  and  $\varphi$  are constants derived from experimental data. Table 4.7 shows the values for the constants.

For the interfaces between a GCL and soil, or a GCL and a textured geomembrane (GMX) a nonlinear model was developed by Duncan et al. (1978). In this case, shear strength is computed as:

$$\tau = \sigma_n \tan \left[ \varphi_0 + \Delta\varphi \log \left( \frac{\sigma_n}{P_a} \right) \right]$$

Where  $\tau$  is shear strength,  $\sigma_n$  is the normal stress, and  $\varphi_0$  and  $\Delta\varphi$  are constants derived from experimental data, and  $P_a$  is equal to the atmospheric pressure (101 kPa). Table 4.7 shows the values for the constants.

Table 4.7 Constants for peak shear stress calculations (from Gilbert et al. 1996)

Interface	Normal Stress Range (kPa)	Linear		Nonlinear	
		C (kPa)	$\phi$ (deg.)	$\phi_0$ (deg.)	$\Delta\phi$ (deg.)
GCL	3.45-23.0	-	-	18.0	-23.0
GCL	23.0-69.0	-	-	30.0	-4.7
GCL/GM	3.45-69.0	0.00	8.4	-	-
GCL/GMX	3.45-69.0	-	-	30.0	-4.7
GCL/GN	3.45-69.0	0.38	23.0	-	-

#### 4.7.2 Infiltration layer

For the design of infiltration barriers in reburial systems, the example set by landfills can be followed. Landfills employ liner systems at the bottom of the landfill to prevent leachate infiltration, and these have been proven to perform well in the field. Liner systems can incorporate elements such as compacted clay liners, geotextiles, geomembranes, and geosynthetic clay liners (GCL). As these elements come with different placement methods, and different levels of protection against infiltration, it is important to choose the adequate liner system for the site. The wrong infiltration barrier may not provide an adequate level of protection for the archaeological material, or conversely it may provide more protection than necessary and cause the project to go over budget. The hydraulic conductivity of a GCL is the most important parameter to evaluate when designing an infiltration barrier for a reburial system. The site hydrological conditions must be evaluated to determine the maximum hydraulic conductivity of the infiltration barrier, and whether to use a GCL, or a composite liner system.

The design of the infiltration barrier is dependent on both the archaeological material (how sensitive it is to infiltration caused damage) and on the environmental conditions at the site (how much precipitation is expected). Thus, accurately determining the necessary level of protection against infiltration is crucial. Based on sensitivity factors, the environmental number ( $N_E$ ) can be calculated for guidance in design. Although this can be done in many ways, the following three approaches are recommended. However, as with all recommendations within the DAISEE method, these should be used as guidelines and all decision should be subject to the engineer responsible of the design.



1.)  $N_E \leq 1$ : This represents the cases where either the site is not at risk due to decay processes brought on by infiltration. In these cases, an infiltration barrier is not necessary. This occurs because the site is not subject to heavy precipitation, or where environmental degradation of the archaeological material is not a large concern.

Sites in arid climates are usually in this category, although if the archaeological material is hypersensitive to moisture related damage (like Chacon Canyon and Aztec Ruins, in southwestern U.S.) it can still be the principal method of decay. Sites where the archaeological material is not susceptible to this type of damage (for example sites that consist mostly of glass and ceramic artifacts) will also commonly be in this category.

2.)  $1 < N_E < 2.5$ : This represents situations where the site is moderately at risk for environmental damage. For these cases a moderate amount of protection may be needed. Because the site is not subjected to extremely heavy rainfall and the material is not extremely sensitive to environmental damage, the use of a light barrier against infiltration is recommended.

Geosynthetic clay liners (GCLs) have been used in a variety of application as an infiltration barrier with great success. GCLs provide an effective barrier to infiltration, at a lower cost than geomembranes and are easier to install (Kavazanjian 2004). GCLs can be installed without skilled seaming technicians, and are generally more rugged, and require less care during installation to prevent damage from compaction of overlying layers, backfilling, or construction traffic. Additionally GCLs can also serve as a protective cushion layer (Kavazanjian 2004) offering additional protection against loading and impact from overlying layers.

3.)  $N_E \geq 2.5$ : This is for cases where the archaeological material is either very sensitive to changes in groundwater level or chemistry, and the site is subject heavy rainfall. Because of the high potential for the archaeological material to be damaged, it is extremely important that the infiltration barrier provide adequate protection. Sites which have a large amount of dry archaeological wood, mosaics, or other mud-based structures will likely be in this category, as they will be very sensitive to changes in moisture content.

Because these sites are very susceptible to environmental damage, it is crucial to limit the infiltration into the archaeological layer. To accomplish this, a composite liner system is recommended. A composite liner system consisting of a geomembrane with a geosynthetic clay liner (GCL) underlying it is generally considered to be the most effective type of engineered infiltration barrier (Kavazanjian 2004). These systems have been employed to great success in landfills, where an effective infiltration barrier is required at the bottom. Because of the critical nature of preventing infiltration in landfills, composite liner systems are often augmented with a secondary composite liner, which incorporates an additional geomembrane and low-permeability soil layer or GCL. However, a single composite liner should be adequate for most applications in reburial systems, even in this category.

Another liner that could be used as an infiltration barrier is a Compacted Clay Liner (CCL), as this liner is made of natural materials, it may present a cost advantage over geosynthetics if the material is readily available. However, the compacting effort necessary for the installation of the CCL may damage the archaeological material, especially if the CCL is placed near it. For this reason, the use of CCLs is discouraged, unless the safety of the archaeological material can be guaranteed.

### 4.7.3 Irrigation and drainage systems

#### 4.7.3.1 Irrigation systems

Where an irrigation system is needed, a 'leaky pipe' irrigation system like the one installed at the Rose (Ashurst et al. 1989) should provide enough water to maintain a suitable groundwater level. Because of the large number of waterlogged timbers present at the Rose, this system was designed to maintain the groundwater table at a sufficient level. Maintaining the groundwater table above the timbers was critical in ensuring the preservation of the site, because the wood would quickly decay if allowed to dry. The system has been carefully monitored throughout the last 20 years, and the remains appear to be satisfactorily conserved. This monitoring data also consists of the most complete long-term monitoring data set available for a reburial project. However, the new reburial system design for the Rose eschews the irrigation system, and instead relies on natural processes to maintain the moisture level needed. If a leaky pipe irrigation system is to be installed at the site, the designer can follow the example of the Rose, as it has been proven to work in reburial systems. The irrigation lines should be placed above the archaeological material, placed 1500 mm apart. The irrigation lines should then be covered with an impermeable geosynthetic. Leaky pipe irrigation systems have also been used in landfills.

The design of a leaky pipe irrigation system should specify the following factors:

- a.) Type of pipe material
- b.) Diameter and wall thickness of the pipes
- c.) Size and distribution of the perforations in the pipe
- d.) Pipe bedding material, and required compaction of the bedding

As the goal of a leaky pipe irrigation system is to maintain saturated conditions in the archaeological layer, hydrological studies at the site must be undertaken to accurately determine the position of the groundwater table and the seasonal fluctuations, if any. The design of the irrigation system should be made using the deepest location of the water table, as this will be the most critical condition for the irrigation system. The required flow rate can be calculated as:

$$Q_{req} = q_{max} * A_{irr}$$

Where  $Q_{req}$  is the required flow rate,  $q_{max}$  is the maximum unit area irrigation requirement (which is determined based on site hydrological conditions), and  $A_{irr}$  is the area to be irrigated by the pipe (which is determined by the layout of the irrigation system).

There are many materials available for the construction of pipes. Polymeric pipes are most commonly used, and HDPE and PVC are used almost exclusively (Qian et al. 2001). In order to determine the pipe properties, a process of trial and error using Manning's equation is used. The flow rate of the pipe is calculated using an assumed pipe size, and the diameter is adjusted until a suitable pipe size is found. The calculated flow rate for the selected pipe must be greater or equal than the required flow rate for irrigation. The pipe flow rate can be computed as:

$$Q = \left(\frac{C}{n}\right) * A * r_h^{2/3} * S^{1/2}$$

Where Q is the flow rate of the pipe, C is a constant (1.49 in Imperial units, 1.0 for SI units), A is the cross-sectional area of the pipe,  $r_h$  is the hydraulic radius, and S is the pipe slope. The hydraulic radius can be computed as:

$$r_h = \frac{A}{P_w}$$

Where  $A$  is the flow area, and  $P_w$  is the wetted perimeter. For full pipe flow, the hydraulic radius is computed as:

$$r_h = \frac{D_{in}}{4}$$

Where  $D_{in}$  is the inside pipe diameter.

To determine the number of perforations needed along the pipe, the following equation can be used:

$$N = \frac{Q_{out}}{Q_b}$$

Where  $N$  is the number of perforations in a unit length of pipe,  $Q_{out}$  is the maximum outflow rate per unit length of pipe, and  $Q_b$  is the maximum outflow rate of a single perforation. To compute the maximum outflow rate per unit length, the following equation can be used:

$$Q_{out} = \frac{Q_{req}}{L_{pipe}}$$

Where  $L_{pipe}$  is the total length of the pipe. The maximum outflow rate of a perforation ( $Q_b$ ) can be calculated using Bernoulli's equation. The equation is:

$$Q_b = C_d * A * \sqrt{2gh}$$

Where  $C_d$  is the discharge coefficient (0.62 is commonly used),  $A$  is the perforation area,  $g$  is the gravitational constant, and  $H$  is the height of water above the perforation.

When perforated pipes are placed in a granular filter material (such as a sand layer), the material must be coarse enough to not enter the perforations. For circular perforations this can be achieved by selecting a filter material which satisfies the following condition:

$$\frac{\text{85 \% Size of Filter Material}}{\text{Hole Diameter}} = 1$$

Pipes which are subjected to loads may fail due to excessive deflection. Passage of heavy equipment directly over a pipe must be avoided. Whenever possible, pipes should be installed in a negative projection which limits the load on the pipe. In order to ensure that the pipe will not rupture or break under excessive load, or buckle and/or collapse the pipe deflection must be computed. The horizontal pipe deflection ( $\Delta X$ ) can be computed as:

$$\Delta X = \frac{D_L * K * W_c * r^3}{E * I + 0.061E' * r^3}$$

Where  $D_L$  is the deflection lag factor (ranges from 1 to 2.5),  $K$  is a bedding constant (see Table 4.8),  $W_c$  is the vertical load per unit length on the pipe,  $r$  is the mean radius of the pipe,  $E$  is the elastic modulus of the pipe,  $I$  is the moment of inertia of the pipe (computed as  $t^3/12$  where  $t$  is the wall thickness of the pipe), and  $E'$  is the soil reaction modulus (see Table 4.9).

Table 4.8 Values of bedding constant K (from Qian et al. 2001)

Bedding Angle, $\phi$ (degree)	Bedding Constant, K
0	0.110
30	0.108
45	0.105
60	0.102
90	0.096
120	0.090
180	0.083

Table 4.9 Average values of soil reaction modulus for short term flexible pipe deflection (from Qian et al. 2001)

Soil type for the pipe bedding material (USCS)	E' for degree of compaction of bedding			
	Dumped	Slight (< 85 % Proctor, < 40% relative density)	Moderate (85-95 % Proctor, 40-70 % relative density)	High (> 95 % Proctor, > 70 % relative density)
Fine grained soils (LL > 50 %) CH, MH, CH-MH	No data available, consult a soils engineer or use E' = 0			
Fine grained soils (LL < 50 %) CL, ML, CL-ML	50 psi	200 psi	400 psi	1000 psi
Coarse grained soils with over 12 % fines GM, GC, SM, SC	100 psi	400 psi	1000 psi	2000 psi
Coarse grained soils with less than 12 % fines GW, GP, SW, SP	200 psi	1000 psi	2000 psi	3000 psi
Crushed rock	1000 psi	3000 psi	3000 psi	3000 psi

The vertical load on a perforated pipe can be computed using the following equation:

$$W_c = \frac{[(\sum \gamma_i * H_i) + \sigma_z] * D_o}{(1 - n * d/12)}$$

Where  $\gamma_i$  and  $H_i$  are the unit weight and thickness of the fill materials above the pipe,  $\sigma_z$  is the stress felt by the pipe due to a stress applied at the surface (if any),  $D_o$  is the outside pipe diameter, n is the number of perforations in a unit length of pipe, and d is the diameter

of the perforations. The unit weight of the fill will be dependent on the fill material chosen in the fill design process. The height of the material above the pipe will be dependent on where in the fill the irrigation system is placed. The minimum value is zero (if the material is placed at the top of the fill) and the maximum value is the total height of the fill (if the irrigation system is placed at the bottom of the fill). The stress felt by the pipe due to a surface load can be determined using 2:1 theory, as in the fill design section.

The deflection ratio of the pipe must be less than the allowable deflection ratio. The allowable deflection ratios are listed in Table 4.10, and are dependent on the Standard Dimension Ratio (SDR). SDR can be computed as:

$$SDR = \frac{D_o}{t}$$

Where  $D_o$  is the outside diameter of the pipe, and  $t$  is the pipe thickness. The deflection ratio (DR) can be calculated using the following equation:

$$DR = \frac{\Delta Y}{D}$$

Where  $\Delta Y$  is the vertical deflection of the pipe ( $\Delta Y \cong \Delta X$ , for  $\Delta X \leq 10\%$ ), and  $D$  is the mean pipe diameter.  $D$  can be computed as:

$$D = \frac{D_o + D_i}{2}$$

Where  $D_o$  is the outside diameter of the pipe, and  $D_i$  is the inside diameter of the pipe.



Table 4.10 Allowable deflection ratio of polyethylene pipe (from Qian et al. 2001)

SDR	Allowable Deflection Ratio
11	2.7%
13.5	3.4%
15.5	3.9%
17	4.2%
19	4.7%
21	5.2%
26	6.5%
32.5	8.1%

Lastly, pipes must be checked for buckling. Buckling can occur due to insufficient pipe stiffness. Buckling may govern design of flexible pipes subjected to internal vacuum, external hydrostatic pressure, or high soil pressures in compacted soil (Qian et al. 2001).

The factor of safety for pipe buckling can be determined by:

$$FS = \frac{P_{cr}}{P_{tp}}$$

Where  $P_{cr}$  is the critical buckling pressure, and  $P_{tp}$  is the actual vertical pressure at the top of the pipe.  $P_{cr}$  can be computed with the following:

$$P_{cr} = 2 * (G_b * E')^{1/2}$$

Where  $G_b$  is computed as:

$$G_b = \frac{2E}{3 * (1 - \mu^2)} * \left(\frac{t}{D}\right)^3$$

Where  $\mu$  is the Poisson's ratio for the pipe material. The vertical pressure on top of a perforated pipe ( $P_{tp}$ ) can be computed as:

$$P_{tp} = \frac{(\sum \gamma_i H_i) + \sigma_z}{(1 - n * d/12)}$$

Where n is the number of perforations per unit length of pipe, and d is the diameter of the perforations.

#### 4.7.3.2 Drainage systems

Drainage layers are often used in reburial applications where it is important to provide a dry environment and presence of water due to significant infiltration, or subsurface hydrology, is expected. While a drainage layer will not stop the presence of water in the archaeological layer in the way that an infiltration barrier would, it is effective at removing the water present in the reburial system. Drainage layers have been used extensively in landfills to drain leachate, and can be constructed of either natural or manmade materials.

**Drainage using soil:** Natural soils (sand and gravels) are used extensively in landfills (Qian et al. 2001). The most popular use is for leachate collection layers, but they are also used as leak detection layers, gas collection layers, drainage layers in a final cover system, and as drainage trenches. Commonly, 2 feet thick sand layers are used for primary draining layers, and 1 foot thick layers are used for secondary drainage.

The hydraulic conductivity of the sand is the most important material characteristic. It is recommended that the hydraulic conductivity be greater than  $1 \times 10^{-2}$  cm/sec. The sand should also be free of organic material, should have less than 5 % fine content (passing the #200 sieve), and should have 100 % passing the 3/8-inch sieve (Qian et al. 2001).

**Drainage using geosynthetics:** Recently, both geotextiles and geonets have been used in landfills as leachate drainage layers. The hydraulic conductivity of a geonet is much greater

than that of sand, which makes it an attractive alternative. A thin geonet can be used instead of several feet of sand (Qian et al. 2001), thus reducing the total thickness of the reburial system. This is especially useful in reburial systems with overhead constraints due to post-reburial land use. A geotextile is placed on top of the geonet to act as a filtration layer and to prevent soil migration. When a geotextile and geonet are used as a primary drainage system, a 2 feet thick layer of sand must be placed above it for protection. The sand should have a hydraulic conductivity greater than  $1 \times 10^{-4}$  cm/sec.

#### 4.7.3.3 Design of a drainage layer

To design a drainage layer, the required flow rate ( $q_{req}$ ) must be calculated.

$$q_{req} = \frac{r * L_{Hmax} * dw}{dw}$$

Where  $r$  is the inflow rate to the drainage layer,  $L_{Hmax}$  is the maximum horizontal distance to a vertical drain, and  $dw$  is a reference length (1 foot or 1 metre).

The drainage layer should meet the required drainage rate ( $q_{req} \leq q_{allow}$ ). The material selected should have the necessary drainage capacity. If the material is a geonet, then:

$q_{allow} = \frac{q_{ult}}{FS}$ , where  $q_{ult}$  is a material property of the geonet, and  $FS$  is a factor of safety.

If the material is a sand then:

$$q_{allow} = \frac{q_{ult}}{FS} = \frac{1}{FS} * \left( k * \frac{\Delta h}{L_{Hmax}} * A \right)$$

Where  $k$  is the sand permeability,  $\Delta h$  is the hydraulic head, and  $A$  is the cross sectional area of the sand layer.

The drainage system should be underlain by an infiltration barrier, if no barrier was selected in the previous step, a GCL should be used. The drainage system should be designed so that vertical drainage is provided.

#### **4.7.4 Reinforcement**

The reinforcement needed will vary according to the demands placed on the site by the future use of the site. The reinforcement should be designed by a qualified engineer to ensure that any subsequent construction will be able to be supported by the soil without excessive settlement. The design should also ensure that the applied load (due to either the reburial system or the overlying construction) will not be damaging to the archaeological material.

If reinforcement is needed, geotextiles, geogrids, and geocells can all be used. Woven geotextiles are often used in reinforcement applications. Typical applications for geotextiles serving as reinforcement are improving the foundation-bearing capacity, enhancing sub-grade stability when placing fill over soft soils, and construction of mechanically stabilized earth walls (Kavazanjian 2004). Mechanically stabilized earth (MSE) walls and embankments can be constructed easily with high-strength woven geotextiles. Backfill can be stabilized with geotextile reinforcement to reduce the lateral load applied to the wall of the structure. Geogrids can also be used to reinforce earth fill placed on top of subgrade soils (Kavazanjian 2004). Geogrids are often used for shallow burial and low-overburden reinforcement applications (Kavazanjian 2004).

Reinforcement in the fill can be used to improve the bearing capacity of the soil. This can be performed with both geotextiles, and geogrids. However, in order for the reinforcing effect of the geosynthetics to be mobilized, there needs to be a measurable settlement. This is due to the geosynthetic needing to deform before its reinforcing effects can be realized.

Figure 4.10 shows the bearing capacity improvement for soils using geotextiles. Figure 4.11 shows load versus deflection curves of a soil reinforced using geogrids. Both figures show a marked improvement in the bearing capacity of the soil. In both cases, the selection of an appropriate geosynthetic should be performed based on the allowable tensile stress of the fabric. The acting tensile stress on the geosynthetic should be evaluated, and a geosynthetic fabric capable of carrying these stresses should be chosen.

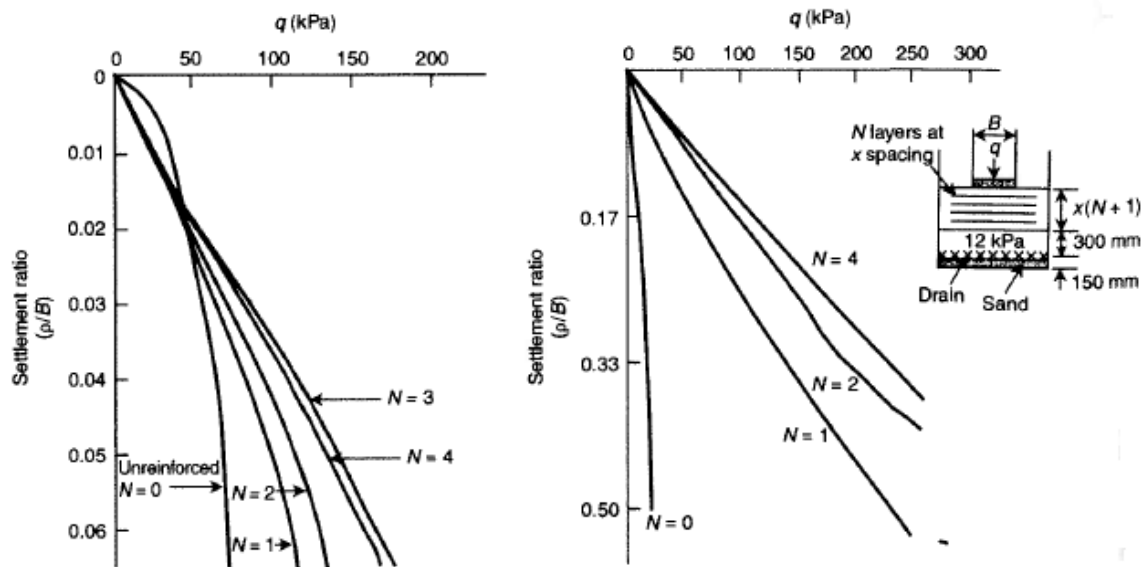

Figure 4.10 Laboratory developed curves showing improvement in bearing capacity of soils using geotextiles;  $p$  is the footing settlement and  $B$  is the footing width. On the left, (a) was developed using non-woven geotextiles spaced 140 mm on a loose sand ( $D_R = 50\%$ ) with a square footing. On the right, (b) was developed using geotextiles spaced 40 mm on a soft saturated clay using a round footing (from Koerner 2005).

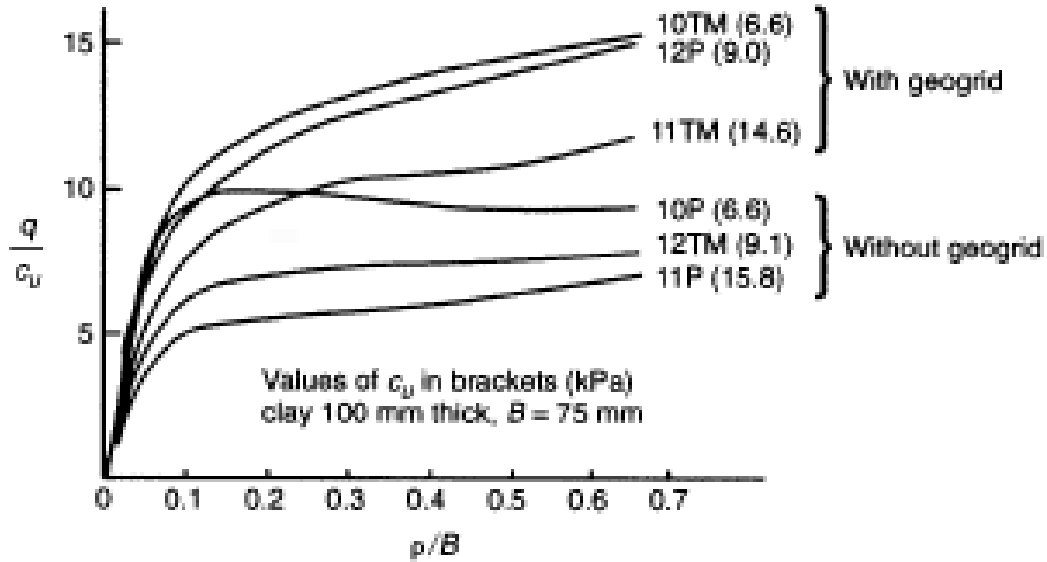

Figure 4.11 Load versus deflection curves for soils with and without geogrid reinforcement

Geogrids and geotextiles can also be used as reinforcement to minimize or eliminate differential settlements. The reinforcement can span the area of a localized subsidence, for example that due to weak spots in the underlying material. In this case the required tensile strength of the reinforcement can be computed as:

$$T_{reqd} = \sigma_r * R * \Omega$$

Where  $\sigma_z$  is the vertical stress on the reinforcement layer, R is the radius of the differential settlement zone, and  $\Omega$  can be computed as:

$$\Omega = 0.25 \left( \frac{2y}{B} + \frac{B}{2y} \right)$$

Where B is the width of the settlement void, and y is the depth of the settlement void. The vertical stress on the reinforcement layer  $\sigma_r$ , can be computed as:

$$\sigma_r = 2\gamma_{ave}R \left[ 1 - e^{-0.5H/R} \right] + qe^{-0.5H/R}$$

Where  $\gamma_{ave}$  is the average unit weight of the material above the settlement area, H is the height above the settlement area, and q is the surcharge pressure applied at the surface.

As the reinforcement strength of the geosynthetic is mobilized, it's necessary that the soil maintaining the geosynthetic in place resist pullout. The fabric should be installed in the reburial system to provide the length required; if this is not possible due to restrictions in the reburial system dimensions or construction sequence, physical methods of attachment (such as attachment of the fabric to a timber structure) should be evaluated. The necessary length for pullout can be computed as:

$$L_{req} = \frac{T_{act}}{2E(c_a + \gamma_{ave}H \tan \varphi)}$$

Where  $T_{act}$  is the stress acting on the geosynthetic, E is the pullout efficiency of the geosynthetic (0.8-1.2 for geotextiles, and 1.3-1.5 for geogrids),  $c_a$  is the adhesion of the goesynthetic to the soil,  $\gamma_{ave}$  and H are the average unit weight and height of the material above the geosynthetic, and  $\varphi$  is the friction angle of the soil.

#### 4.7.5 Fill

As stated before, fill is the principal component of a reburial system by volume. Fill volume is often determined by the conditions at the site. The constraints placed on the reburial system by the land use after the reburial project has concluded often limit the depth of fill. However, if depth of fill can be chosen, there are advantages to both shallow and deep fills. Shallow fills are less costly, because they require less material and work. However, they

provide a less stable environment and offer less protection for the archaeological material. Chances for damage from root penetration, water infiltration, frost, vandalism, and surface heat or fire are all increased with a shallow fill. Deep fills both provide more protection and more opportunities for specialized design, but are also more costly. If frost damage is a strong possibility, fills should always be designed to exceed the frost line.

If the artifact assemblage is sensitive to load ( $S_L \geq 1$ ), a lightweight deep fill can be designed so that stresses dissipates. Based on experimental data, artifacts in a matrix of soil can resist an applied load of 50 psi. As the applied load is transferred to the soil, it is dissipated with depth. Using 2:1 theory, we can calculate the stress at a depth  $z$  due to an applied load at the surface. By capping the stress at the archaeological material at 100 psi, we can calculate the required depth of fill.

Thorne (1991) states that *“The design plan for intentional burial must be conceived in a manner that will insure that maximum protection is afforded the resource while minimizing any negative effects caused by such an overburden”*. This can be achieved by utilizing lightweight fill whenever possible. In the Bristolkvarvalet reburial system, expanded polystyrene foam and expanded clay pellets were both used as lightweight fill. Controlled low strength material (CLSM) could also be used as a fill, as it flows to fill the space in which it is installed. A CLSM fill would have the benefit of being much easier to excavate, if access to the archaeological material is needed.

Demas (2004) refers to specialized fill materials as *“either natural or synthetic materials that perform a specific function within a reburial matrix. These functions can be to encourage drainage or, conversely, impede the free flow of water, promote capillarity,*



*provide insulation and facilitate or impede removal*". She lists sand, pozzolana, expanded clay pellets, and gravel as commonly used specialized fills. Other specialized fill include vermiculite, polystyrene, perlite and geof foam.

If natural soil is used for the fill, the soil should be compacted after placing it. The compactive effort should be determined by an engineer, and it should be high enough to ensure proper compaction of the fill but pose no threat to the survival of the archaeological material. Although the overall load on the archaeological material increases with depth of fill, the stresses and vibrations that may be present at the surface (from construction activities for example) dissipate with depth. Hester (1988) recommends that fill be placed at a rate of 2 to 4 feet a day to prevent artifact damage.

#### 4.7.5.1 Engineering properties of fill

There are many engineering properties of fills which are of particular concern to the practice of archaeological reburial. As fill will provide the bulk of the reburial system, it is important to select a fill material that will have the required characteristics to meet the performance goals set by the project.

As fill can be made of different materials, not all properties apply to every material. For example, gradation and compaction characteristics are crucial when selecting a particulate fill material (like sand), but become meaningless with a non-particulate, self-compacting fill (like CLSM). Chesner et al. (1998) present a summary of important engineering properties for fill, as well as the test procedures to determine them, presented in Table 4.11.

The most important properties for fill are:

**Gradation:** Fill materials which are well graded are usually recommended for embankment construction. The reason is that well-graded materials can achieve higher densities after compaction, which leads to higher shear strength, lower permeability and less compressibility. Commonly, well graded material is also recommended for archaeological reburials for the similar reasons. However, poorly graded soils can be used if the project requires it.

**Unit Weight and Specific Gravity:** Fill materials can vary in unit weight over a fairly wide range, depending on the type of material and its moisture content (Chesner et al. 1998). Low weight fill materials are attractive in archaeological reburial applications as they reduce the load placed on the archaeological material due to the weight of the fill.

**Moisture-Density Characteristics:** The compaction characteristics (optimum moisture content and maximum dry density) of a soil fill material are the most important single property that affects embankment performance (Chesner et al. 1998). Compactive effort can be applied to fill material in order to change its unit weight, permeability shear strength, and compressibility which are all critical properties of fill. Specifications for fill commonly require the material to be placed at an in-situ density of 95 percent or greater of the maximum dry density of the material.

**Shear Strength:** The shear strength characteristics (cohesion and/or internal friction) are indicative of the ability of a fill material to support loads that are imposed upon it under given drainage conditions (Chesner et al. 1998). When there is to be overlying construction after the burial has taken place, shear strength can often be a controlling factor in the selection of fill material.

**Compressibility:** Compressibility is the tendency of the material to lose volume under a long-term load condition. The compressibility of a fill material is related to its shear strength, degree of compaction, void ratio, permeability, and degree of saturation (Chesner et al. 1998). Some settlement of the fill is to be expected if placed under load. However, both total and differential expected settlement should be calculated as part of the design process to ensure they will not pose a serious threat to the reburial system performance.

**Bearing Capacity:** Bearing capacity refers to the ability of a fill material to support the loadings imposed upon it over the life of the facility without undue settlement, volume change, or structural damage (Chesner et al. 1998). The bearing capacity of a fill may be determined in either field or laboratory conditions.

**Permeability:** Permeability (also called hydraulic conductivity) is the ability of a fill material to allow the passage of a liquid through its pore structure at a given flow rate. This property is of the utmost importance for fill in archaeological reburial systems as the presence of water can start environmental decay processes that can damage and destroy buried archaeological remains. Fills made of cohesive soils, or manmade material can be made to either impermeable or to allow for the free passage of water.

**Corrosion Resistance:** Corrosion is a basic chemical or electro-chemical property of a material that can induce damage to concrete or metallic structures or elements placed in contact with the material. Because the archaeological material may come in contact with the fill, and water flowing through the fill may reach the archaeological material, it is of the utmost importance that the fill be free of any chemical products that can damage the

assemblage. Ideally, fills should be chemically inert, and that is commonly the recommendation (Canti and Davis 1999).

Table 4.11 Important engineering properties for fill material and corresponding testing methods

Property	Test Method	Reference
Gradation	Particle Size Analysis of Soils	ASTM D422
	Sieve Analysis of Fine and Coarse Aggregate	ASTM D136
Unit Weight and Specific Gravity	Unit Weight and Voids in Aggregate	ASTM D29
	Specific Gravity of Soils	ASTM D854
	Relative Density of Cohesionless Soils	ASTM D2049
	Maximum Index Density of Soils Using a Vibratory Table	ASTM D4253
	Minimum Index Density of Soils and Calculation of Relative Density	ASTM D4254
Moisture Density Characteristics	Moisture-Density Relations of Soils and Soil-Aggregate Mixtures Using 5.5 lb (2.49 kg) Rammer and 12 in. (305 mm) Drop	ASTM D698 (Standard)
	Moisture-Density Relations of Soils and Soil-Aggregate Mixtures Using 10 lb (4.54 kg) Rammer and 18 in. (457 mm) Drop	ASTM D1557 (Modified)
Compacted Density (In-Place Density)	Density of Soil in Place by the Sand-Cone Method	ASTM D1556
	Density and Unit Weight of Soil in Place by the Rubber Balloon Method	ASTM D2167
	Density of Soil and Soil-Aggregate in Place by Nuclear Methods (Shallow-Depth)	ASTM D2922
	Density of Soil in Place by the Sleeve Method	ASTM D4564
Shear Strength	Unconsolidated Undrained Compressive Strength of Cohesive Soils in Triaxial Compression	ASTM D2850
	Direct Shear Test of Soils Under Consolidated Drained Conditions	ASTM D3080
	Consolidated-Undrained Triaxial Compression Test on Cohesive Soils	ASTM D4767
Compressibility	One-Dimensional Consolidation Properties of Soils	ASTM D2435
	One-Dimensional Consolidation Properties of Soils Using Controlled-Strain Loading	ASTM D4186
	One-Dimensional Swell or Settlement Potential of Cohesive Soils	ASTM D4546
Bearing Capacity	California Bearing Ratio (CBR) of Laboratory-Compacted Soils	ASTM D1883
	Bearing Ratio of Soils in Place	ASTM D4429
Permeability	Permeability of Granular Soils by Constant Head	ASTM D2434
Corrosion Resistance	pH of Soil For Use in Corrosion Testing	ASTM G51
	Field Measurement of Soil Resistivity Using the Wenner Four-Electrode Method	ASTM G57
	Pore Water Extraction and Determination of the Soluble Salt Content of Soils by Refractometer	ASTM D4542

#### 4.7.5.2 Compacting and placing procedures

Compaction is the act of densifying the fill material through the application of compactive energy. Compaction of a soil is a function of four variables: 1.) compactive energy, 2.) moisture content 3.) gradation of the fill, and 4.) dry density of the fill. The maximum dry density (the densest configuration of particles) occurs at a specific moisture content (optimum water content). These values are determined in the laboratory through either the standard proctor test or the modified proctor test.

The appropriate placing and compacting of fill will strongly impact the in-situ properties of the fill material. Thorne (1991) recommends that once a fill material which best fits the preservation purposes of the reburial has been selected, *“the engineer will be charged with designing the mechanics of the burial procedure. His or her level of understanding must extend from fill acquisition and placement to the hydraulic properties of the site [...]. He or she will also be responsible for designing the placement of the fill so the site components will not warp as a result of heavy equipment movements or the weight of the fill column over time.”*

Specialized equipment is often used to transmit the compactive energy to the fill. For granular soils, vibratory compaction is often used. However, care should be used when employing vibratory methods in an archaeological reburial as the vibrations from the compacting equipment may negatively impact the archaeological material. Cohesive soils are usually compacted by kneading. Because the impacts of kneading compaction on archaeological material have not been studied, care should be applied not to damage the material through kneading. However, ensuring that there is an appropriate thickness of fill material under the compacting equipment to protect the assemblage should prevent damage

to the archaeological material. Figure 4.12 (Holtz and Kovacs 1981) shows the compaction curves for many common types of soil which can be used as fill.

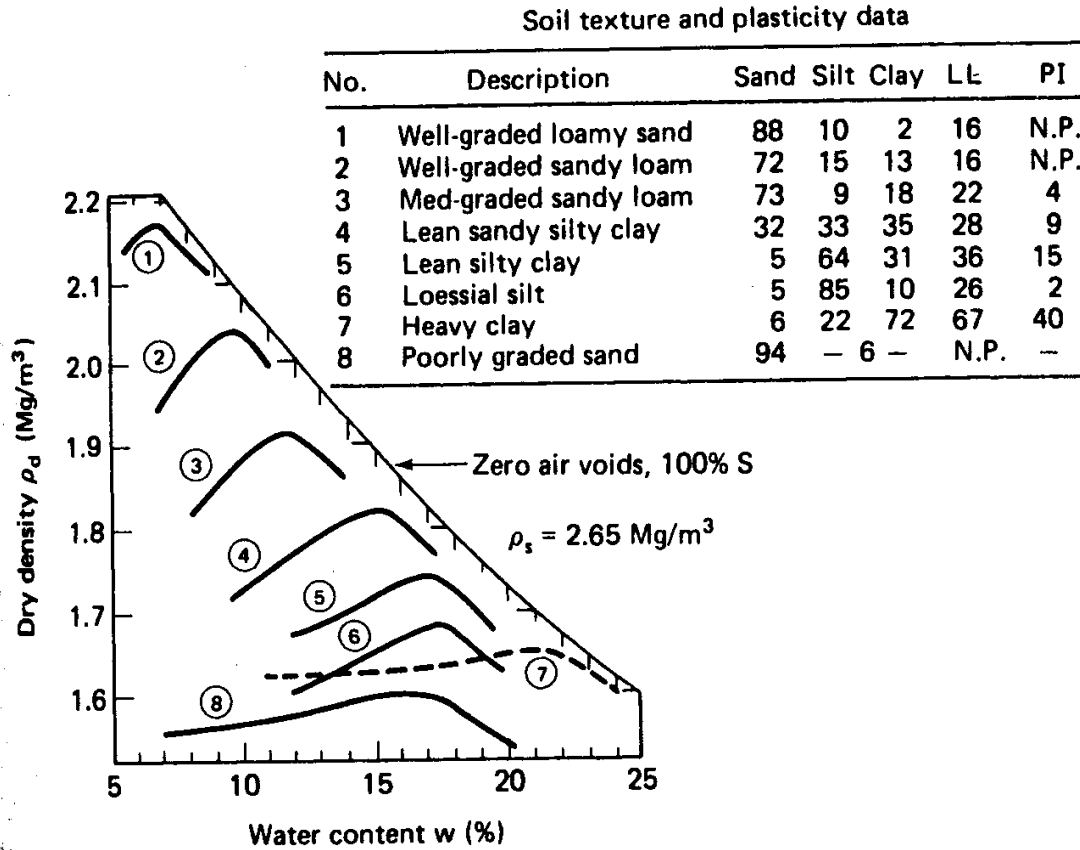

Figure 4.12 Water content-dry density relationships for eight soils compacted according to the standard proctor method (from Holtz and Kovacs 1981)

#### 4.7.5.3 Types of fill

Many types of fill can be used for archaeological reburial systems. Traditionally, clean, chemically inert sands have been recommended, especially in the U.K. (Canti and Davis 1999). However, as there is a high demand on this material from various industries (especially glassmaking) and borrow pits may not be available locally, this can have a great impact on the budget of the project.

Another common material used as fill is the in-situ soil, commonly the one removed from the excavation (Johnsen 2009). As the soil is available, and must be disposed of, using in-situ soil can commonly be done without much expense. Another reason for using the in-situ soil is that since the material was found in the soil, it is thought that re-using it will restore the environment that had protected the material from its deposition until its excavation. However, this is not necessarily the case as the act of excavation may have introduce new elements into the soil or disturbed it in another way that can produce an environment not conducive for preservation.

The Bristolkvartalet reburial system used expanded clay pellets and Expanded Polystyrene blocks (geofoam) in order to prevent adding excessive load to the archaeological layer. The use of lightweight fill is recommended for sites with an assemblage sensitive to load.

Fill type	Advantages	Disadvantages
Soil	<ul style="list-style-type: none"> <li>• Continuity of capillarity</li> <li>• Stable moisture regime</li> <li>• Availability and low cost</li> </ul>	<ul style="list-style-type: none"> <li>• Contains seeds and small plants</li> <li>• Promotes vegetation and animal activity</li> <li>• More frequent maintenance</li> <li>• Difficulty of removal</li> </ul>
Sand	<ul style="list-style-type: none"> <li>• Less susceptible to growth of vegetation and animal activity</li> <li>• Clean</li> <li>• Less frequent maintenance</li> </ul>	<ul style="list-style-type: none"> <li>• Discontinuity of capillarity</li> <li>• Less stable moisture regime</li> </ul>
Gravel	<ul style="list-style-type: none"> <li>• Less susceptible to growth of vegetation and animal activity</li> <li>• Clean</li> <li>• Ease of removal</li> </ul>	<ul style="list-style-type: none"> <li>• Discontinuity of capillarity</li> <li>• Unstable moisture regime</li> <li>• Sharpness</li> </ul>
Specialized materials (clay pellets, tuff pellets)	<ul style="list-style-type: none"> <li>• Less susceptible to growth of vegetation and animal activity</li> <li>• Clean</li> <li>• Ease of removal</li> <li>• Lightweight</li> </ul>	<ul style="list-style-type: none"> <li>• Discontinuity of capillarity</li> <li>• Unstable moisture regime</li> <li>• Availability and cost</li> </ul>

Figure 4.13 Commonly used fill materials for the reburial of mosaics (from Roby 2004)  
 Roby (2004) presents a summary (Figure 4.13) of commonly used fill materials for archaeological reburial. Although this summary is focused on reburial of mosaics, it covers the range of fill materials which are typically used for archaeological reburial. Roby presents the advantages and disadvantages of each material, although he focuses mostly on

the capillarity regime of the soil, its ease of excavation, and the susceptibility to promote vegetation growth. Although this provides a useful summary, it is clearly from an archaeological point of view. For example, Roby lists soil, sand and gravel as three separate types of fill material. By doing this, Roby is making a distinction between in-situ soil (soil) and borrow soil (sand and gravel), although in-situ soil could be classified as sand or gravel.

#### 4.7.5.4 Natural materials as fill

Natural materials are the most commonly used in archaeological reburials. Early reburial projects simply consisted of placing the in-situ soil which was removed into the excavated pit (Johnsen 2009). Common benefits to using in-situ soil include providing good capillary moisture transport which will help control the moisture content in the reburial environment, and that since the soil is the material that helped preserve the site until excavation, it is usually compatible with the remains (Roby 2004). However, due to the innate variability of soils, testing is required to predict the performance of the material. Natural fill material can also come from borrow pits. However, borrow material can quickly inflate the budget of a project, especially if the source is not local. Common borrow material include clean sands, gravels, and crushed stone.

**Sand:** Sand is the most commonly used borrow soil in reburial projects (Canti and Davis 1999). Common specifications for sand to be used in reburial projects include having a low amount of fines (under 5 %), and the sand being chemically inert. Sands also have a high permeability, which may be necessary in sites where good drainage is required. However, it will leave the archaeological material susceptible to infiltration, so a barrier may be needed. Some of the benefits of using sand as fill are that *“it is often easily available and inexpensive without being as susceptible to growth of vegetation and animal activity as in-*



*situ soil. It is 'cleaner', meaning it has fewer small particles and fewer organic materials and contaminants such as salts” (Roby 2004). A disadvantage of using sand as a fill material is that commonly it is compacted through vibratory methods, which may negatively affect the archaeological material or the archaeological context.*

**Gravel:** Gravel presents some of the same benefits as sand (easily available, discourages the growth of vegetation and animal activity, is chemically inert) with the added benefit of commonly being able to achieve higher shear strengths than sand. In projects where the reburial system is to bear loads from overlying construction, the higher shear strengths achieved with gravel may be needed. However, as in sands, compaction of gravels is also commonly performed through vibratory methods which may negatively impact the preservation of a site. Additionally, because gravel has sharp edges, it should never be placed in direct contact with the archaeological material.

**Cohesive soils:** Cohesive soils are commonly used in reburial fills if they are the in-situ soil. When cohesive borrow soils are recommended it is due to the low permeability layers that can be achieved with them. For example, the second Shardlow boat reburial used a borrow low-permeability bund made entirely of clay to protect the boat remains from desiccation. However, cohesive soils can present several issues when used as archaeological reburial fill. Firstly, clays can have chemical properties which are damaging to the archaeological material. Secondly, expansive clays can present a high shrink/swell potential which would compromise the integrity of the reburial system. Additionally certain cohesive soils can have a high settlement potential.

**In-situ soil:** The in-situ soil will likely be a combination of cohesive (clay and silt) and non-cohesive (sand and gravel) soils. As this is the medium in which the archaeological material has survived, it is often used as fill in reburial systems. However, as soils are inherently highly variable, the properties of the in-situ soil should be determined before using it as fill material.

#### 4.7.5.5 Synthetic materials as fill

A number of synthetic materials (also called specialized fills) can be used for archaeological reburial systems. Some of the advantages of using synthetic materials is that they can be lightweight, easy to install, easy to excavate, and do not promote vegetation growth. Some of these materials are also thermally and chemically resistant. However, these specialized materials can be more expensive than natural fill materials.

**Lightweight aggregate:** Expanded Shale, Clay and Slate (ESCS) provide many benefits over using conventional fill materials. These materials are approximately half the weight of natural soils and provide a consistently high angle of internal friction, high stability, high permeability and high thermal resistance. This makes them very attractive for sites in which the archaeological assemblage is sensitive to load or thermal changes, and the fill is expected to be load bearing.

**Expanded clay pellets:** Expanded clay pellets have been used in the past for the reburial of archaeological sites. The advantages are that it's a lightweight material that is easy to install, excavate, and re-use if needed, while it does not promote vegetation growth. This material is used in both the Bristolkvartalet and the mosaic reburial system.

**Vermiculite:** Vermiculite is a lightweight expanded mineral fill that has been proposed for use in archeological reburial systems. The main advantages is that the material is lightweight, provides thermal insulation, and is easy to install. However, it is not recommended to be used in situations where the fill is to be load bearing. The mosaic reburial system recommends using a layer of vermiculite as part of its design.

**Expanded Polystyrene (EPS):** Commonly called geofom, this material takes the form of low-density plastic blocks made from expanded polystyrene. These blocks are easily installed and are a lightweight, stable, inert fill. The main advantage of using geofom is that its density is very low compared to conventional fill material (approximately 1 %). This material was used in the Bristolkvartalet reburial system in order to protect the remains from overlying load. Because each block can be carried and installed by 2 people, this material is an attractive option for sites with a small construction staff.

**Wood fiber:** Wood fiber has been used as a lightweight fill for embankment construction. The wood fiber is generally compacted in 12 inch thick lifts and should not have particles above 6 inches. To prolong the life of the fill, only fresh wood fiber should be used. In order to prevent leachate formation, the amount of infiltration should be minimized. When used in archaeological reburials, this necessitates an infiltration barrier below the fill. However, reburial designs which already had an infiltration barrier in place will not be affected. Another disadvantage of using wood fiber for fills is that they have a high propensity for creep settlement.

**Controlled Low Strength Material:** Controlled Low Strength Material (CLSM) is a self-consolidating cementitious material that can be used as a flowable fill. CLSM is composed

of a fine aggregate (usually sand), water, and a cementitious materials, which can be Portland cement, pozzolana, or coal fly ash. The benefits of using CLSM is that it can be designed to suit the needs of the project. The resulting layer can be lightweight, corrosion resistant, thermally resistant, and have low permeability. Because the layer is self-compacting it is easy to install and will not require compactive effort which may disturb the archaeological material and context. The layer can also be easily excavatable if designed with a strength under 100 psi. One of the advantages is that the CLSM is flowable and can fill hard to reach places. However, care should be taken not to let the CLSM come into contact with the archaeological material as it could irretrievably damage it and its context. Although CLSM can cost more per cubic yard than other fill materials, the advantages in placing can result on an overall lower cost.

#### 4.7.5.6 Fill material comparison

Table 4.12 summarizes the engineering properties of possible fill materials for archaeological reburial. This table is intended to help in the selection of an appropriate fill for an archaeological reburial system. However, the final decision on the fill material must be taken by an engineer at the site, in conjunction with an archaeologist to ensure that the reburial system meets both archaeological and engineering performance goals.

#### 4.7.5.7 Fill design

Because fill is typically the largest component of a reburial system, it is of critical importance to select the appropriate fill material and dimensions. Oftentimes, fill dimensions will be dictated by the post-reburial use of the land. The plan dimensions of the reburial system may cover a fraction or the entirety of the archaeological site, depending on research and conservation goals. Reburial system thickness is often dictated

by post-reburial land use, since many applications will require the reburial system to reach the ground surface or another chosen level. Fill volume plays a large role in fill material selection as pecuniary concerns often limit the available materials to those easily available

Table 4.12 Engineering properties of fill materials

Material	Unit Weight (pcf)	Permeability	Load bearing	Excavability	Corrosion resistance	Compressibility	Promotes vegetation growth
Sand	100-120	High	Yes	Easy	Yes	Low	No
Gravel	110-130	High	Yes	Easy	Yes	Low	No
Cohesive Soils	100-130	Low	Yes	Medium	No	Medium	Yes
In situ soil	75-130	Variable	Yes	Variable	Variable	Variable	Variable
ESCS	37-65	High	No	Very Easy	Yes	High	No
Expanded Clay Pellets	22	High	No	Very Easy	Yes	Medium	No
Vermiculite	5	High	No	Very Easy	Yes	High	No
EPS	1-2	Low	Yes	Easy	Yes	Medium	No
Wood fiber	50	High	Yes	Very Easy	No	High	No
CLSM	50-150	Impermeable	Yes	Easy	Yes	None	No

The total cost of the fill ( $C_{fill}$ ) can be computed as follows:

$$C_{fill} = c * (B * L * H_{fill})$$

Where  $c$  is the cost per unit volume of the fill material selected,  $B$  and  $L$  are the width and length of the reburial system, and  $H_{fill}$  is the depth of fill of the reburial system. In the cases where fill depth can be chosen, a combination of fill depth and material that best accommodates the engineering requirements placed on the reburial system and the archaeological material should be chosen. This includes selecting a material which has enough bearing capacity to support the loads placed on it and will not suffer excessive settlement, while at the same time minimizing the stress transfer to the archaeological layer.

### Depth of fill

If the depth of fill can be chosen to accommodate the archaeological material, then it can be designed so that stresses applied at the surface can dissipate with depth. In this case, the

fill depth can be designed so that only a low stress that will not damage the archaeological material reaches the archaeological layer.

The total stress felt by the archaeological layer ( $\sigma_T$ ) can be computed as:

$$\sigma_T = \sigma_{fill} + \sigma_z$$

Where  $\sigma_{fill}$  is the stress due to the fill weight, and  $\sigma_z$  is the stress felt by the archaeological layer due to a load at the surface. The stress due to fill is dependent on the unit weight of the fill material, and the fill thickness. It can be computed as:

$$\sigma_{fill} = H_{fill} * \gamma_{fill}$$

Where  $H_{fill}$  is the fill thickness and  $\gamma_{fill}$  is the unit weight of the fill material.

The stress due to fill weight can easily be manipulated by choosing a material with an appropriate unit weight. As stress increases linearly with depth, it is crucial to choose a material with the appropriate unit weight. Figure 4.14 shows different fill materials, and the stresses they add for a given fill thickness.

The selection of fill material should be made based on the archaeological material to be preserved. Archaeological material which are sensitive to load should guide the design towards fill materials which are more lightweight, while archaeological material which is capable of surviving higher stresses may be reburied with full weight materials, such as natural soil.

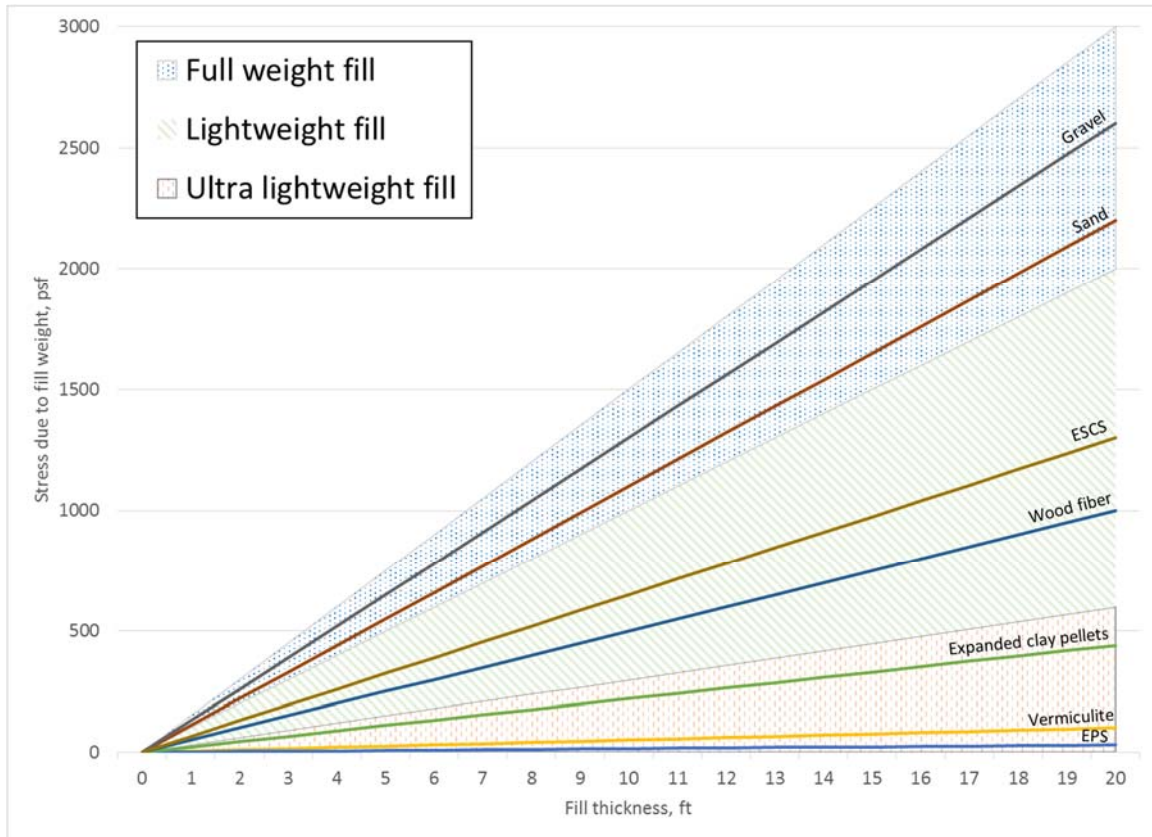

Figure 4.14 Stress due to fill weight with depth

Stresses applied at the ground surface dissipate with depth. One of the simplest methods available to calculate the distribution of stress with depth is the 2:1 method. The 2:1 method assumes that the cross-sectional area, on which the load acts, increases proportionally with depth. As the area increases, the stress decreases. Figure 4.15 shows the 2:1 approximation of vertical stress with depth. This method can be used for both strip and rectangular loads.

For a strip load, the stress felt at a depth  $z$  ( $\sigma_z$ ) is equal to:

$$\sigma_z = \frac{\sigma_0 B}{(B + z)}$$

Where  $\sigma_0$  is the stress applied at the surface, and  $B$  is the width of the load application area.

For rectangular loads, the stress at a depth  $z$  is equal to:

$$\sigma_z = \frac{\sigma_0 B}{(B + z)(L + z)}$$

Where L is the length of the load application area. For square footings, this expression becomes:

$$\sigma_z = \frac{\sigma_0 B}{(B + z)^2}$$

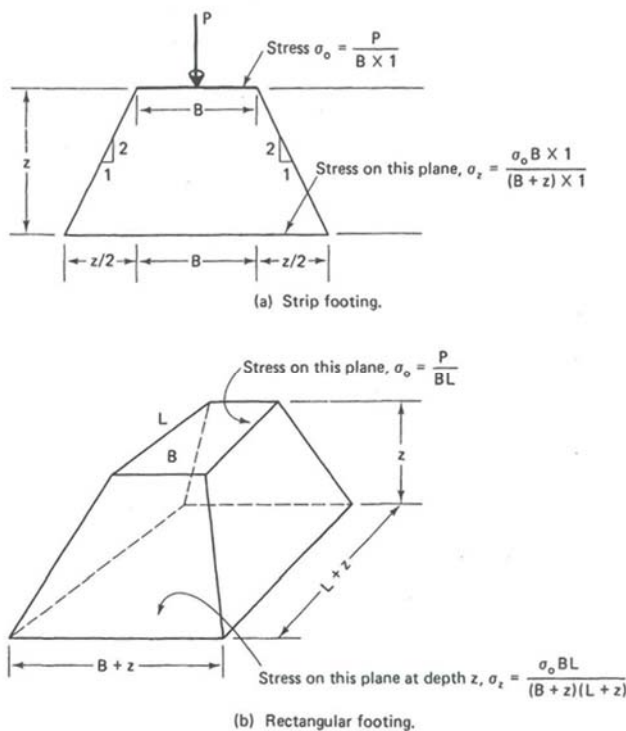

Figure 4.15 The 2:1 approximation for the distribution of vertical stress with depth (from Holtz and Kovacs 1981)

With the 2:1 method, we can also determine fill depth necessary for an applied load to dissipate to a certain level. Although an infinite depth is required to reach zero stress at depth, a negligible stress value can be chosen. From the stress dissipation equations, we



can determine that for a strip loading, the depth  $z_{SD}$  for a specific stress can be computed as:

$$z_{SD} = \frac{B(\sigma_0 - \sigma_z)}{\sigma_z}$$

For a rectangular load, the depth  $z_{SD}$  for a specific stress can be computed as:

$$z_{SD} = \frac{\sqrt{\sigma_z^2 L^2 + (4\sigma_z \sigma_0 - 2\sigma_z^2)BL + \sigma_z^2 B^2} - \sigma_z L - \sigma_z B}{2\sigma_z}$$

If the footing is square, this expression becomes:

$$z_{SD} = \frac{\sqrt{\sigma_z^2 B^2 + (4\sigma_z \sigma_0 - 2\sigma_z^2)B^2 + \sigma_z^2 B^2} - 2\sigma_z B}{2\sigma_z}$$

Figure 4.16 shows the necessary fill depth, for a strip load, so that only a percentage of the applied load reaches the archaeological layer. Because the plots represent a dissipation percentage, this graph can be used with any units of length for foundation width and depth of fill, as long as the units are consistent. Similar graphs can be created for rectangular and square foundations.

Figures 4.17 shows the required depth of fill for a stress of only 25 kPa to reach the archaeological layer for a strip load, and Figure 4.18 shows the required depth of fill for a stress of only 25 kPa to reach the archaeological layer for a rectangular and a square load. Although the depth increases linearly for a strip load, when the load application area is rectangular the depth increases in a parabola shape. This leads to higher stresses being able to be dissipated with a rectangular shape. Currently, there is no clear understanding of the stress that buried archaeological material can be subjected to without damaging or

breaking. Because of this the archaeologist and engineer should collaborate to determine what the acceptable stress will be at the archaeological layer.

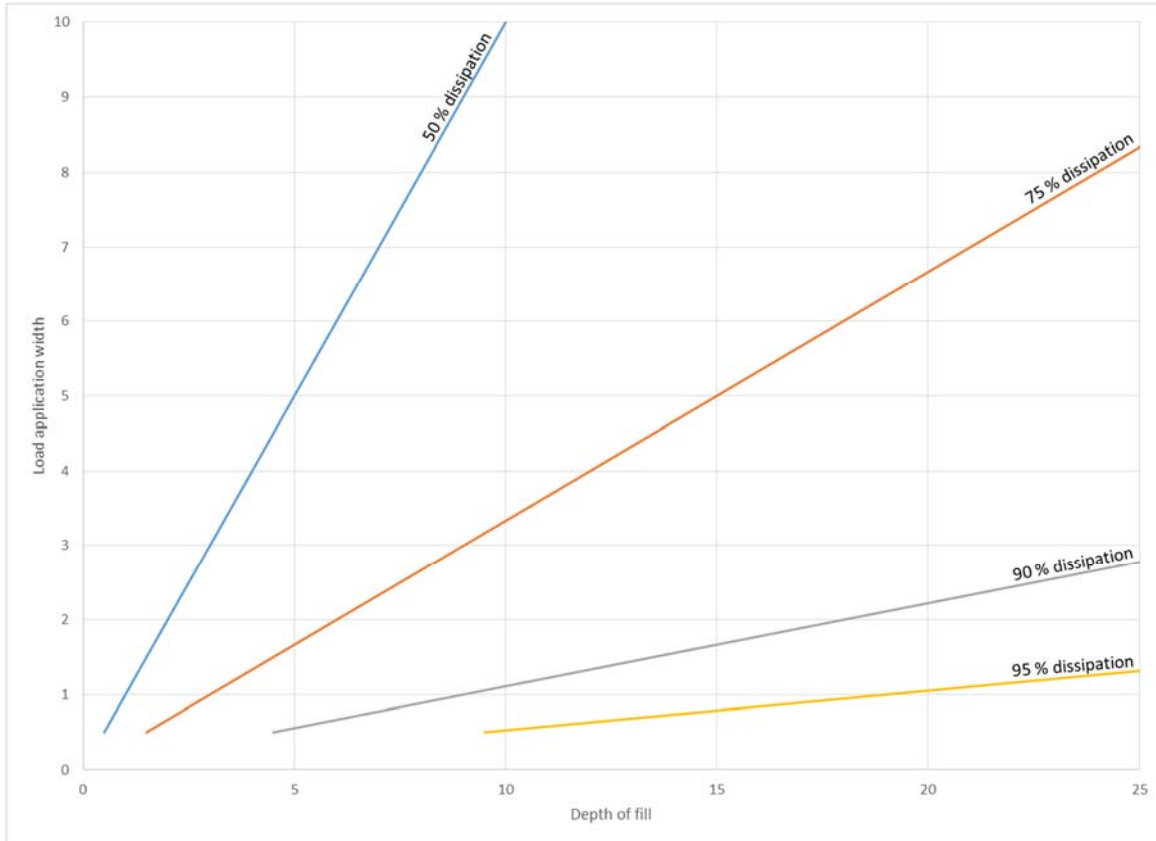

Figure 4.16 Required depth of fill for a given stress dissipation ratio. The graph is unitless, but consistent units need to be used for load and depth.

To produce these graphs, an arbitrary value of 25 kPa was chosen. This stress is equivalent to the one produced by the weight of 1.25 meters of dense sand ( $\gamma = 20 \text{ kN}/\text{m}^3$ ). As more research is produced to accurately determine a “safe stress” value for the archaeological layer, similar graphs can be produced for other stress levels. The “safe stress” will depend mostly on the archaeological assemblage, with fragile materials like glass and ceramic damaging at lower stress levels than materials such as metals. The level of degradation of

the archaeological material also plays an important role, as archaeological material which is more advanced in the decay process being more susceptible to load induced damage.

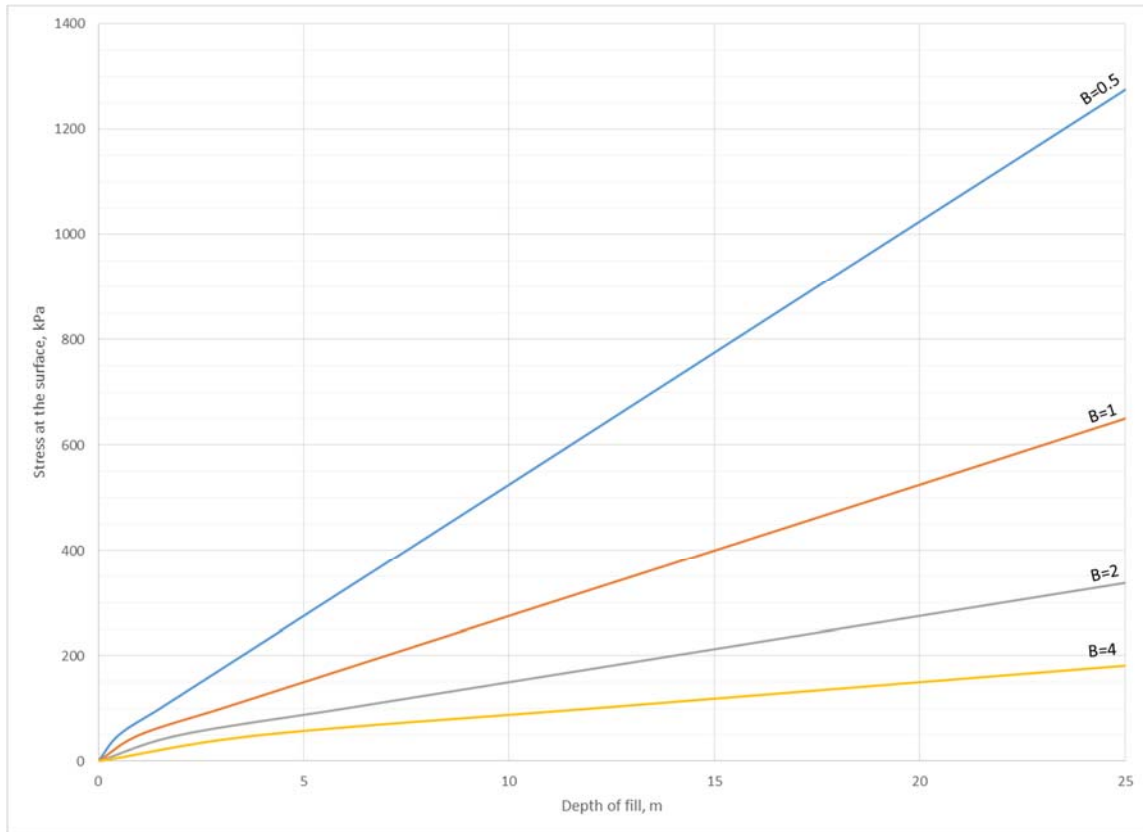

Figure 4.17 Required depth of fill for a stress of only 25 kPa at the archaeological layer for a strip load

Figures 4.19, 4.20, and 4.21 show the dissipation of stress (as a ratio of stress at depth to stress at the surface) with depth (as a ratio of depth to foundation width) for both rectangular and strip foundations. The graphs are unitless, and can be created for any foundation width. The charts presented were produced for foundation widths of 1, 2, and 4 units. Common length to width ratios are presented. In all cases, an increasing  $L/B$  ratio results in a higher value for fill depth to dissipate the same percentage of stress at the archaeological layer. In order to produce the stress dissipation charts, certain assumptions had to be made. First, the load application area was chosen to be either a rectangle, square

or a strip. This reflects common foundation configurations, as building foundations will most commonly be the cause of an increase in applied stress at the surface in most reburial systems. The stress at the archaeological layer was calculated using 2:1 method for the appropriate loading configuration (rectangular or strip). Because reburial systems are subject to a wide range of loading conditions, different loading conditions are presented in the graphs.

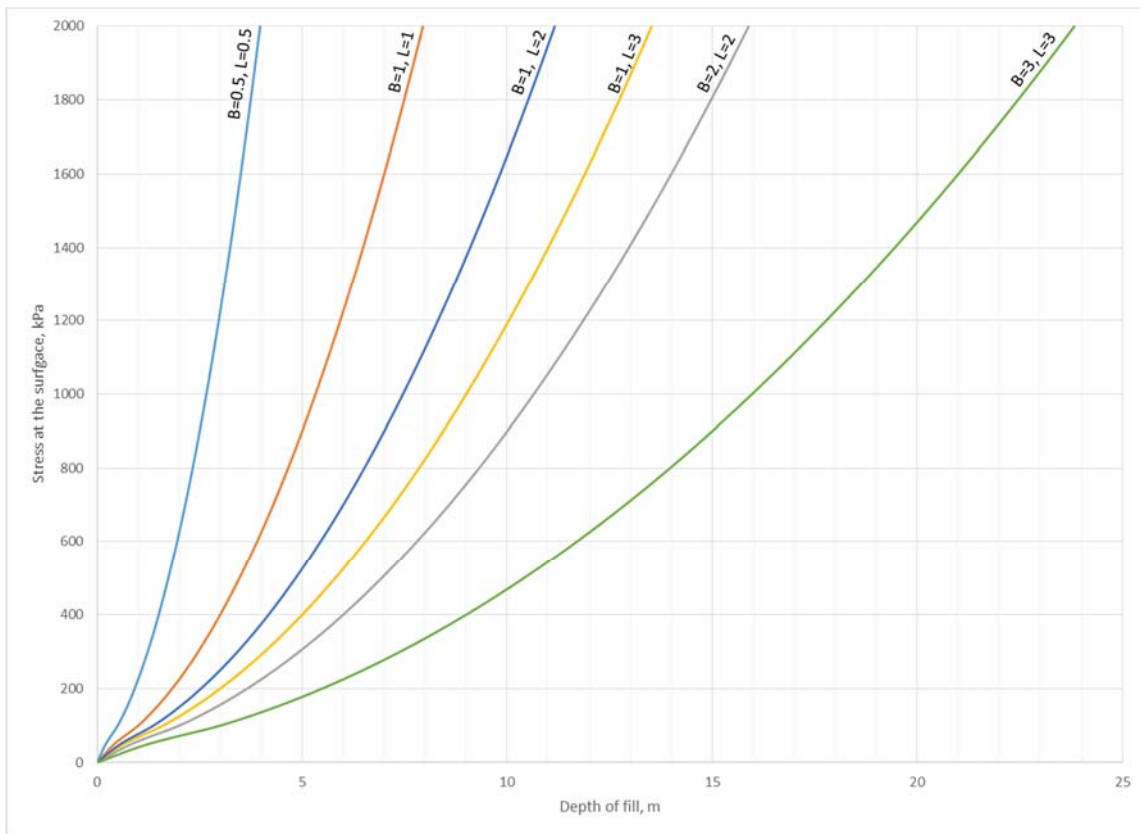

Figure 4.18 Required depth of fill for a stress of only 25 kPa at the archaeological layer for a rectangular or square load

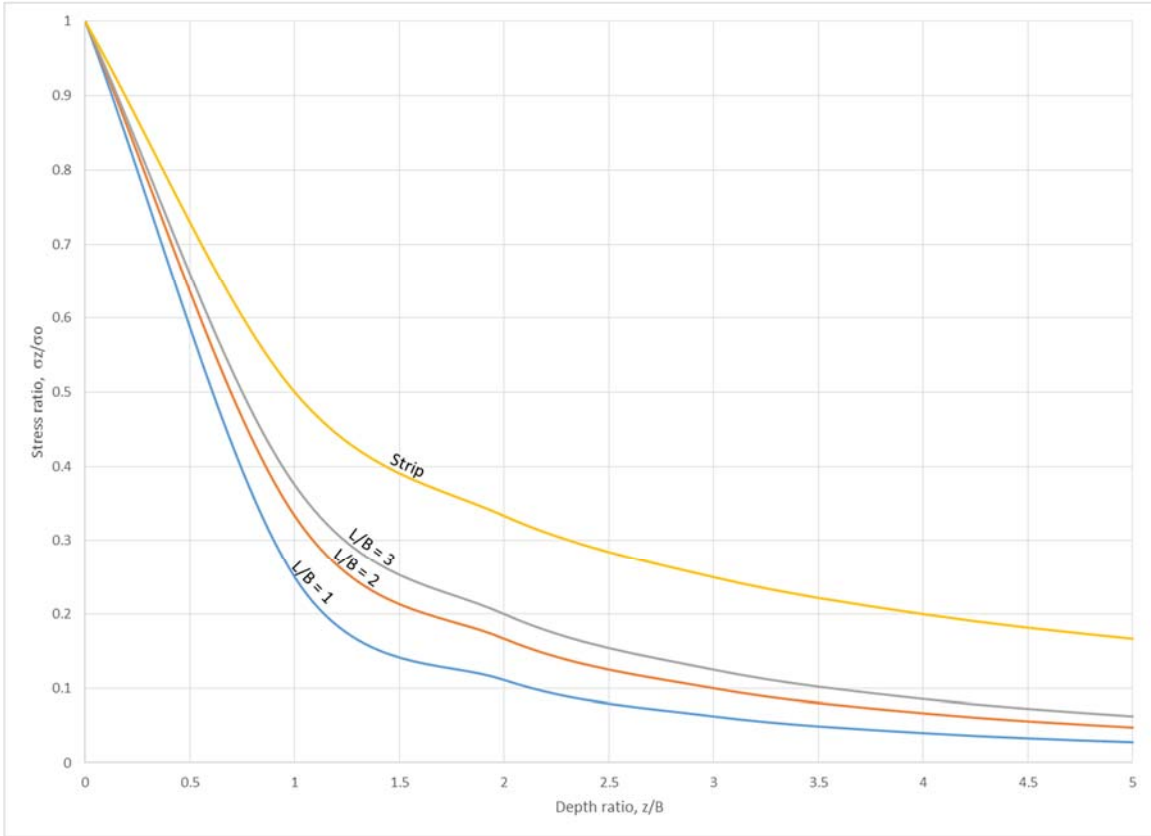

Figure 4.19 Required depth ratio for stress dissipation of a foundation with B=1

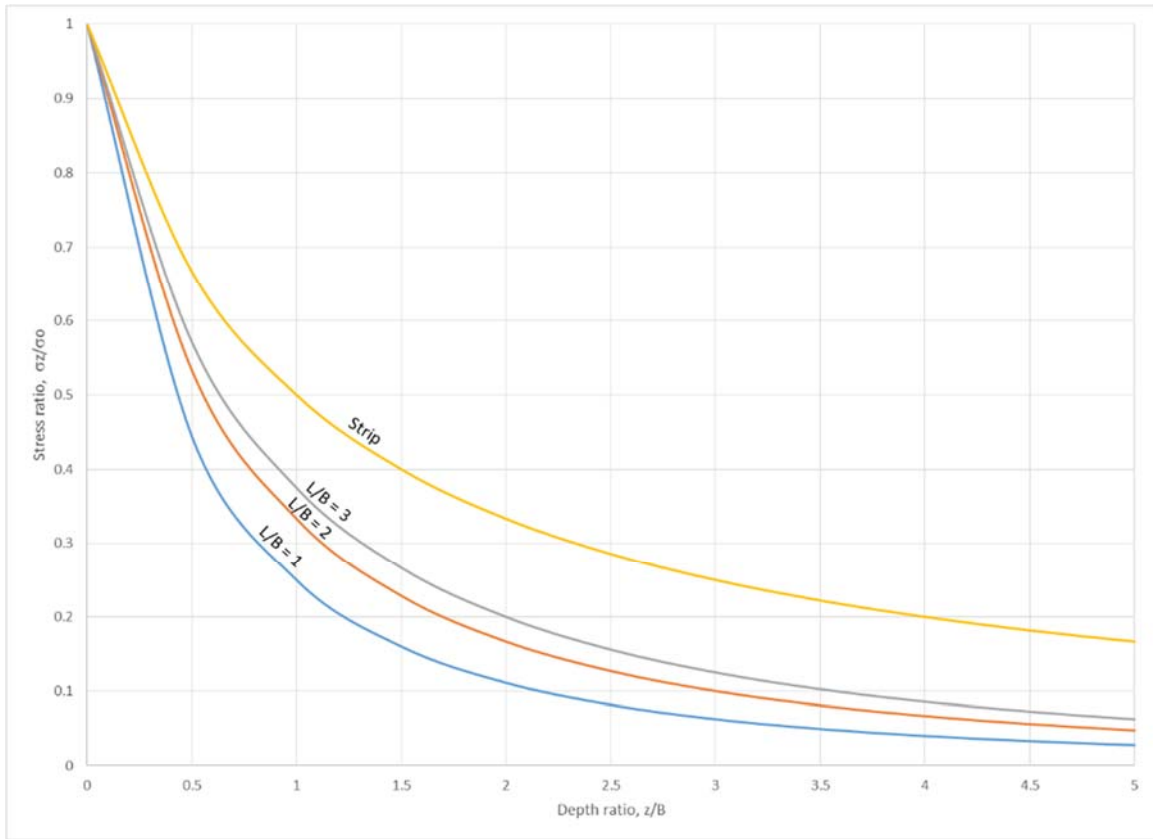

Figure 4.20 Required depth ratio for stress dissipation of a foundation with B=2

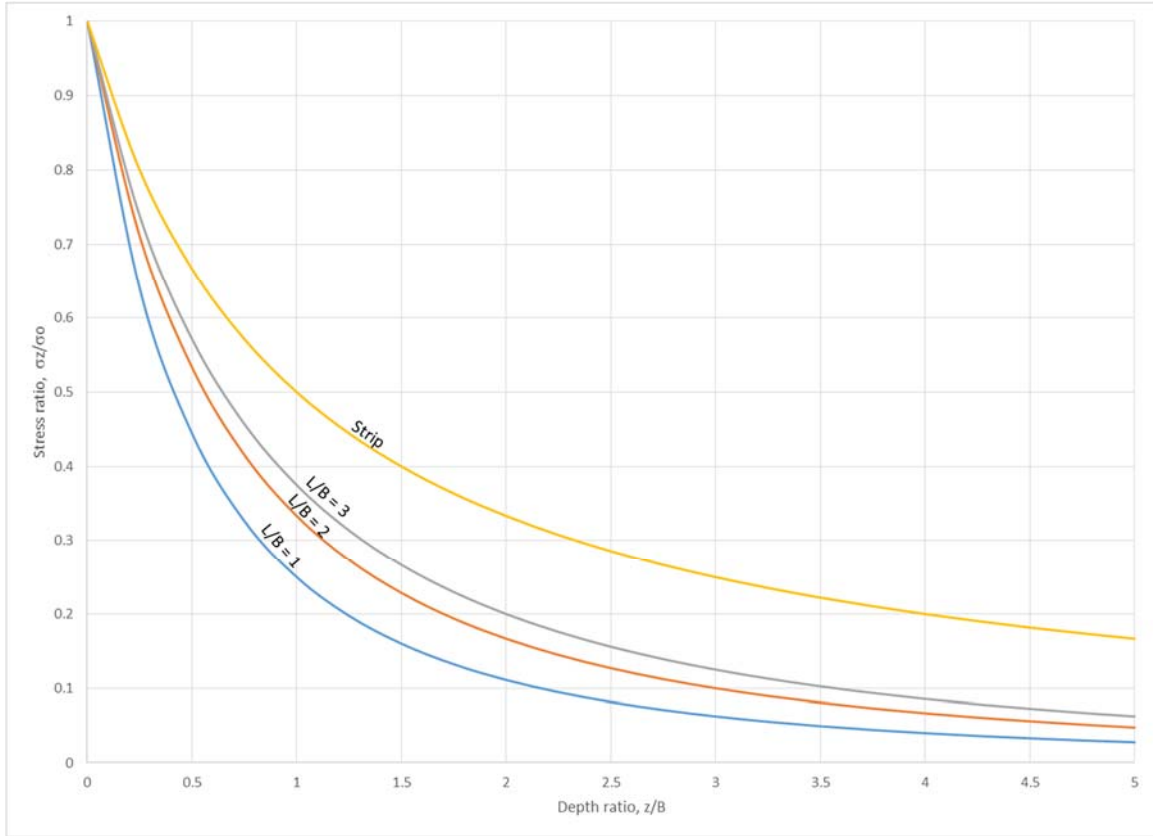

Figure 4.21 Required depth ratio for stress dissipation of a foundation with B=4

### Bearing capacity of fill

The bearing capacity of a soil is the ability of a soil to resist the loads imposed on it without having shear failure of the material. The bearing capacity of a soil is dependent on the internal angle of friction of the soil ( $\phi$ ) and on the cohesion of the soil ( $c$ ). In reburial systems, because the fill material can often be chosen, a fill material with acceptable strength parameters can be used. When designing a shallow foundation, various foundations widths ( $B$ ) can be tried in an iterative process to determine the best design possible. In a reburial system, a variety of dimensions and fill materials with different strength characteristics can be studied until the best alternative is chosen. Terzaghi (1943) developed a set of equations for computing the ultimate bearing capacity ( $q_u$ ) of a soil

under different foundations. This was the basis that Meyerhof (1963) used to develop a general form of the bearing capacity equation in order to account for the foundation shape, the shearing resistance along the failure surface in the soil above the bottom of the foundation, and a possible inclination of the load. The ultimate bearing capacity can be computed as:

$$q_u = C' N_c F_{cs} F_{cd} F_{ci} + \sigma'_v N_q F_{qs} F_{qd} F_{qi} + \frac{1}{2} \gamma B N_\gamma F_{\gamma s} F_{\gamma d} F_{\gamma i}$$

Where  $C'$  is the effective cohesion of the soil,  $\sigma'_v$  is the vertical effective stress under the foundation,  $\gamma$  is the unit weight of the fill material,  $B$  is the width or diameter of the foundation,  $F_{cs}$ ,  $F_{qs}$ ,  $F_{\gamma s}$  are shape factors;  $F_{cd}$ ,  $F_{qd}$ ,  $F_{\gamma d}$  are depth factors, and  $F_{ci}$ ,  $F_{qi}$ ,  $F_{\gamma i}$  are load inclination factors, and  $N_c$ ,  $N_q$ , and  $N_\gamma$  are bearing capacity factors. The bearing capacity factors can be computed as:

$$N_q = \tan^2 \left( 45 + \frac{\varphi'}{2} \right) e^{\pi \tan \varphi'}$$

$$N_c = (N_q - 1) \cot \varphi'$$

$$N_\gamma = 2(N_q + 1) \tan \varphi'$$

Where  $\varphi'$  is the effective friction angle of the fill material. The equations needed to compute the shape factors were determined by de Beer (1970), while the equations for depth factors were determined by Hansen (1970), and the equations for inclination factors were determined by Meyerhof (1963).



Because of the innate variability of soils, and other factors, it is necessary to adjust the ultimate bearing capacity of the soil to obtain the allowable bearing capacity. This is the stress that the soil can safely withstand. The allowable bearing capacity of the fill material is computed as:

$$q_{allow} = \frac{q_u}{FS}$$

The factor of safety depends on the loading condition of the soil and the nature of the overlying construction. Common factors of safety vary between 1.2 and 3.

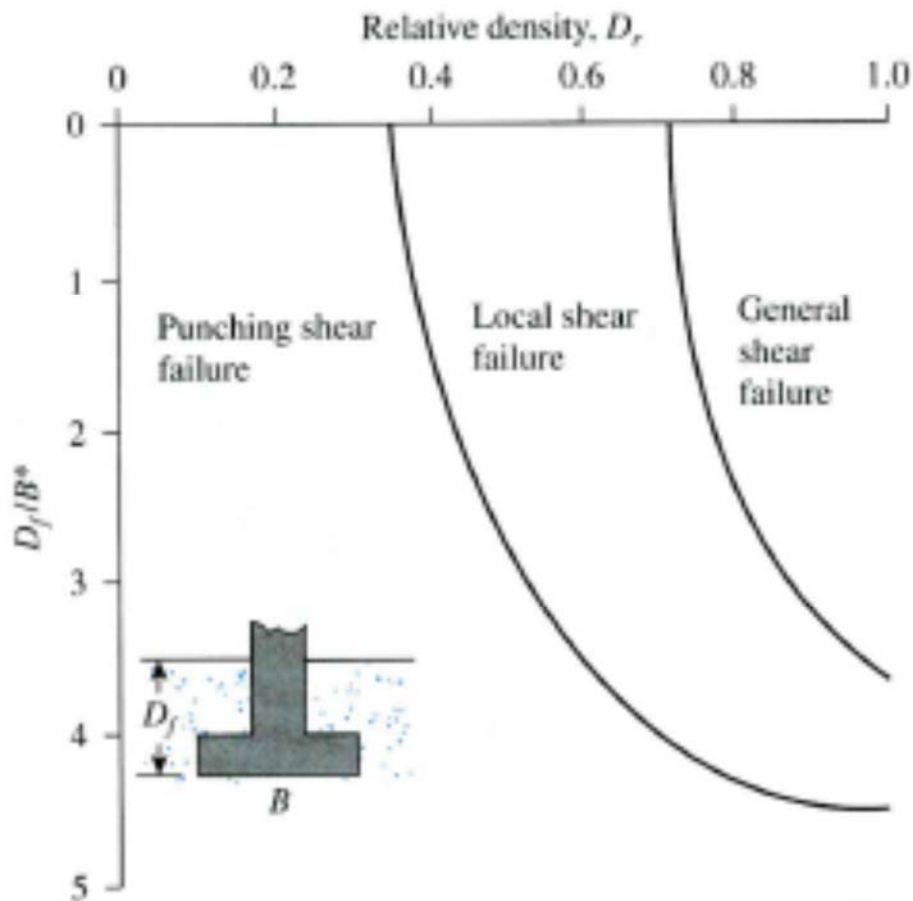

Figure 4.22 Failure modes for shallow foundations in sand (from Vesic 1973)

Bearing capacity failure of a soil can occur in three forms, depending on soil density and on the depth of burial of the foundation ( $D_f$ ). Figure 4.22 shows the failure mechanism for foundations in sand for a range of relative densities and depth of burial to base width ratio. Because the soil bearing capacity is fully mobilized during general shear failure, foundations are commonly designed to have depth to base ratios and be placed in soils with relative densities which place them in this area.

The fill depth beneath the foundation must also be thick enough so that the general shear failure zone is contained to the fill, and doesn't intersect with the archaeological layer. The depth of the failure zone is a function of the internal friction angle of the fill material ( $\phi$ ) and on the width of the foundation ( $B$ ) as illustrated in Figure 4.23, which shows the failure zone for a foundation. Higher friction angles (stronger soil) lead to a greater depth of the failure surface ( $z_{BC}$ ). Thus the compaction of the fill material can strongly affect the depth of the shearing failure zone as compaction directly affects the friction angle of the soil. The choice of fill material, and its placement process, will directly impact the required depth of fill beneath the foundation. However, by having a  $z_{BC}/B$  ratio of no more than 3, the failure zone should be contained in the fill. Likewise, the ratio of depth of burial to base width can affect the failure mechanism of the foundation. The deeper the footing is placed, the more likely that failure will occur in local shear or punching, rather than general shear.

In a reburial system, the foundations will commonly be placed in the fill. The fill thickness ( $H_{fill}$ ) should then be large enough to accommodate the designed foundation depth ( $D_f$ ) and the necessary fill depth to dissipate the load from the foundation ( $z_{SD}$ ), or the necessary fill depth to ensure that the failure zone will be in the fill ( $z_{BC}$ ), whichever value is greater.

$$H_{fill} = D_f + [z_{SD} \text{ or } z_{BC}]$$

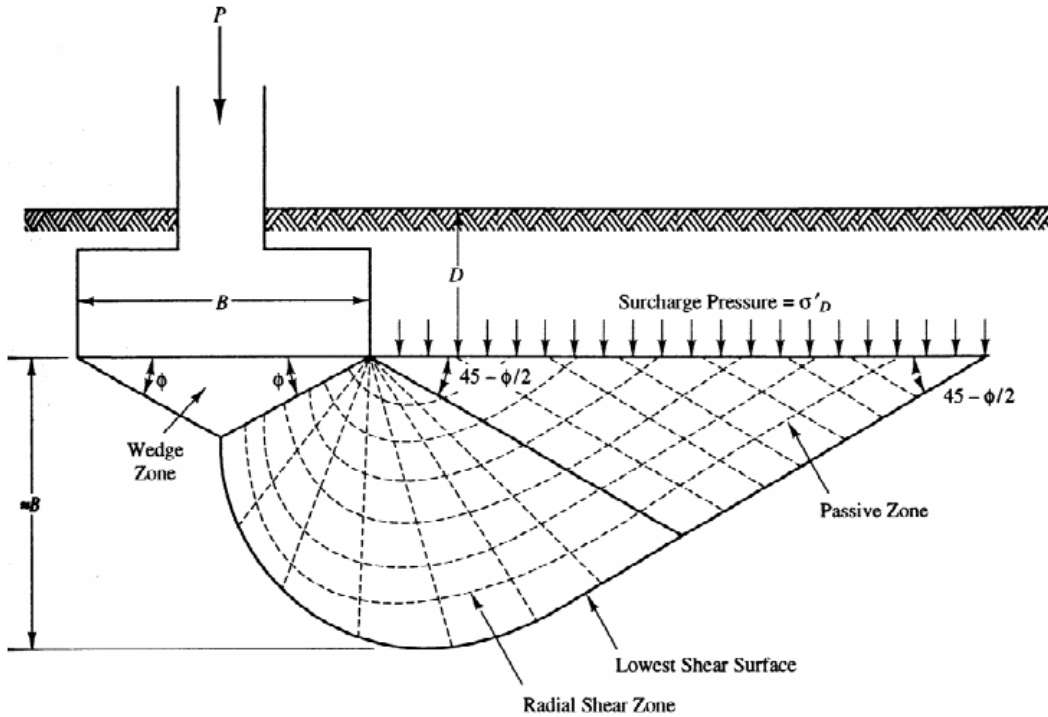

Figure 4.23 General shear failure zone for a foundation (from Das 2010)

Figure 4.24 shows the relationship between the different variables relating to fill thickness. The selection of fill material will strongly impact the required depths, as strength parameters and unit weight play a large role in the determination of foundation dimensions ( $B$  and  $D_f$ ) and in the determination of the required depth below the foundation ( $z_{SD}$  or  $z_{BC}$ ).

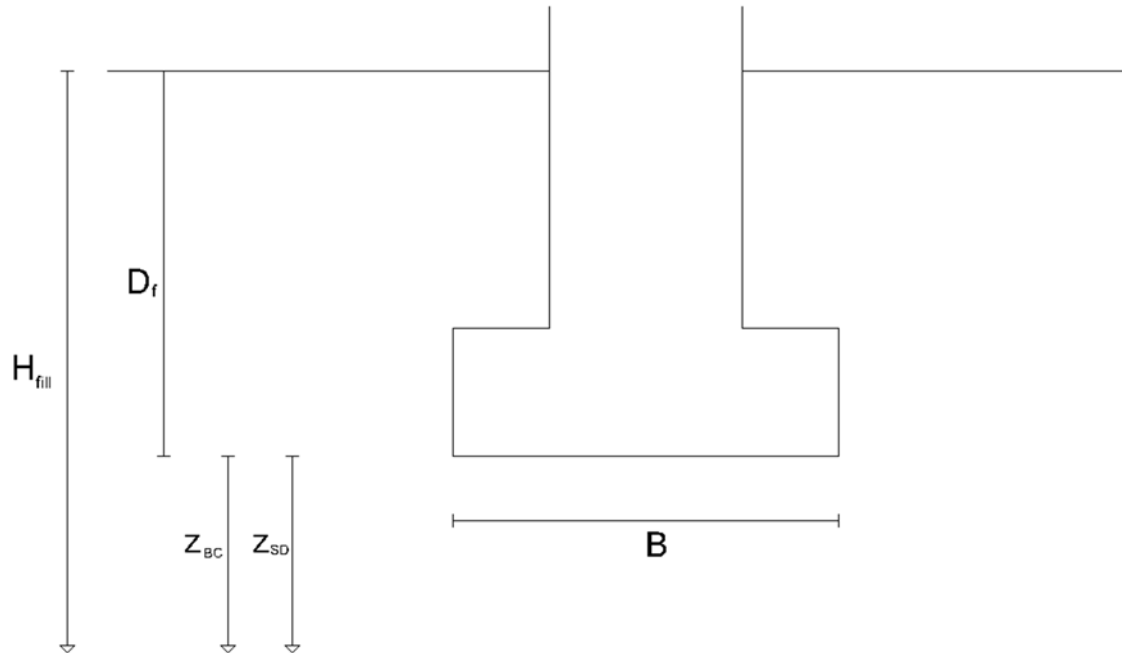

Figure 4.24 Required fill height to ensure both adequate stress dissipation and protection of the archaeological material from bearing capacity failure.  $z_{SD}$  may be calculated using the 2:1 method discussed above, and  $z_{BC}$  will depend on the site conditions, but should be smaller than  $3B$ .

### Settlement of fill

Excessive settlement of the fill can lead to a service failure of the reburial system. Although the settlement of fill will not pose any danger to the conservation of the archaeological material, it may pose a threat to construction overlying the reburial system. If the total or differential settlement of the fill is larger than the allowable settlement, then the reburial system is failing to meet the engineering performance standards necessary. In a reburial system, the principal source of settlement will be the fill layer. However, settlement of the archaeological layer can also induce service failure of the superstructure overlying the reburial system. Settlement in the reburial system can also induce unwanted stresses in components of the reburial system, such as the pipes in an irrigation system. Furthermore,

settlement of the archaeological layer can damage the archaeological material, and poses a serious threat to the archaeological context.

Settlement occurs when there is a reduction of voids in the soil mass. This is commonly due to an increase in load at the surface, such as new construction. Sites that do not experience a surface load increase will not suffer any settlement. Compaction of the fill material will reduce the initial void ratio of the soil, and limit the settlement of the reburial system. The total settlement of a soil mass ( $S_T$ ) is defined as:

$$S_T = S_c + S_s + S_i$$

Where  $S_c$  is the settlement due to consolidation,  $S_s$  is the secondary settlement, and  $S_i$  is the immediate settlement. In order for a reburial system to meet the required performance standards, the total settlement must be equal or less than the allowable settlement ( $S_T \leq S_{allow}$ ).

The immediate settlement of a soil is estimated by using elastic theory. It is computed as:

$$S_i = \Delta\sigma * B * \frac{1 - \mu_s^2}{E_s} * I_p$$

Where  $\Delta\sigma$  is the net vertical pressure applied, B is the width of the load application area,  $\mu_s$  is the Poisson's ratio of the soil (see Table 4.13),  $E_s$  is the modulus of elasticity of the soil (see Table 4.14), and  $I_p$  is a nondimensional influence factor (see Table 4.15). The Poisson's ratio of the soil will also be dependent on the drainage condition. For example, a drained (slowly loaded) clay will have a Poisson's ratio on the lower end of the range (0.2) while an undrained (rapidly loaded) clay will have a value nearer to 0.5. The influence

factor varies due to the shape of the load, whether the load is applied through a flexible or a rigid material, and the specific point under the load where the influence factor is calculated.

Table 4.13 Representative values of Poisson's ratio (from Das 2002)

Type of soil	Poisson's ratio
Loose sand	0.2-0.4
Medium sand	0.25-0.4
Dense sand	0.3-0.45
Silty sand	0.2-0.4
Soft clay	0.15-0.25
Medium clay	0.2-0.5

Table 4.14 Representative values of the modulus of elasticity of soil (from Das 2002)

Soil type	Es	
	kN/m <sup>2</sup>	lb/in <sup>2</sup>
Soft clay	1800-3500	250-500
Hard clay	6000-14000	850-2000
Loose sand	10000-28000	1500-4000
Dense sand	35000-70000	5000-10000

Table 4.15 Influence factors for foundations (based on Schleicher 1926)

Shape	m <sub>1</sub> (L/B)	Ip		
		Flexible		Rigid
		Center	Corner	
Circle	-	1.00	0.64	0.79
Rectangle	1	1.12	0.56	0.88
	1.5	1.36	0.68	1.07
	2	1.53	0.77	1.21
	3	1.78	0.89	1.42
	5	2.10	1.05	1.70
	10	2.54	1.27	2.10
	20	2.99	1.49	2.46
	50	3.57	1.80	3.00
	100	4.01	2.00	3.43

Both consolidation and secondary settlement are time dependent. Consolidation settlement occurs in fully saturated, fine grained soils with a low coefficient of permeability. As the loads are transferred onto the soil structure, pore water gets squeezed out of the soil, allowing the soil grains to rearrange themselves into a denser and more stable configuration. Secondary compression is a continuation of the volume change started during consolidation, but it takes place at a constant effective stress. Secondary compression seems to result from effects at the microscale of soils, and is not yet clearly understood. Secondary compression is usually negligible as it is only a small fraction of total settlement, however the in-situ soil should be evaluated for secondary compression potential as certain soils (like those with high organic content) can be highly susceptible to creep compression. The fill material should be selected to minimize the effects of consolidation and secondary compression.

The consolidation settlement of the soil can be computed as:

$$S_c = C_c * \frac{H_0}{1 + e_0} \log \frac{\sigma'_{vo} + \Delta\sigma_v}{\sigma'_{vo}}$$

Where  $C_c$  is the compression index of the fill material (determined experimentally),  $H_0$  and  $e_0$  are the original thickness and void ratio of the fill material,  $\sigma'_{vo}$  is the vertical effective stress felt by the fill material, and  $\Delta\sigma_v$  is the increase in vertical stress responsible for the consolidation process.

#### 4.7.6 Protection layer

Mathewson and Gonzalez (1988) included the effects of macro-organisms in their sit decay matrix. Burrowing animals are a well-known threat to the archaeological material near the

surface. Deep-rooted vegetation also poses a threat to the archaeological material. As roots grow under the surface, they may damage the archaeological material, disturb the archaeological context, or introduce changes in the burial environment which may start chemical or biological decay processes. Construction related damage (from the movement of heavy machinery, vibrations, or other sources) may also need to be accounted for, as it was in the design of the rose reburial (Wainwright 1989). Construction activities may also introduce impact loading at the site due to heavy objects being dropped on the surface of the reburial. Lastly, the site may also be affected by other human activities such as vandalism or looting. Reburial of the site will prevent both of these activities, as it will render the site and its contents inaccessible.

#### 4.7.6.1 Protection against erosion

Protection against erosion is easy to provide to the archaeological material. By creating a new land surface above the archaeological deposit, erosion processes are transferred to the new surface.

If there are no plans for land use following reburial, the protection layer should be capped by a surface of organically rich soil, which can support shallow rooted vegetation. The presence of plant life should alleviate any erosion problems which are present at the site. Thorne (1991) states that *“revegetation should be a part of the stabilization plan to insure land surface stability, and the newly created land surface can be used for a variety of purposes within specified limits. In specific instances, surface stability can be assured while cash crops are being cultivated in the newly placed fill. Care must be exercised in allowing agricultural production to continue after fill is in place, and there must be regular monitoring to insure that post-burial damage is minimized.”* It is important to select the



right type of vegetation, as deep rooted vegetation can have a negative impact on the preservation of the archeological material, and damage the reburial system itself.

Archaeological sites within reservoir or lake drawdown zones, along the splash zone of lake margins, or in any area where significant surface water flow is expected are prime candidates for erosion protection using a reburial system (Thorne 1991a). However, any reburial placed in wave impact environments must include a hard covering at the surface to protect it. Commonly used materials for this purpose are riprap, bulkhead, or filter fabric.

#### 4.7.6.2 Protection against macro-organisms and vandalism

Burrowing macro-organisms pose a clear danger to the survival of archaeological material, especially ones that are deposited at shallow depths. Burrowing can damage or destroy artifacts, and it irrevocably destroys the archaeological context as the tunnels involve movements of large quantities of earth. Certain burrowing animals are also protected by legislation, and thus can be difficult to remove. In addition, these animals tend to eat and chew on site components, accelerating their decay (Mathewson and Gonzalez 1988).

Vandalism is *“considered to be acts of deliberate or unintentional damage to or destruction of archaeological resources”* (Thorne 1991a). Looting involves the removal of components of the archaeological sites for personal use. Both destroy the archaeological site and its context due to removal and disturbance of artifacts. Because sites reburied can be located in private land, unless there is a legally binding agreement between the owner of the land and the conservation agency there is no efficient alternative to prevent vandalism or looting. Reburial projects only rarely have budget available for ongoing security, so detection of vandalism or looting may take a long time.

In order to protect the site from damage from macro-organisms or vandalism, a protective layer can be included in the reburial system. This layer can be made of either natural materials, or of concrete.

In order to prevent the site from burrowing activity, and from light vandalism or looting a layer of gravel is recommended. A 1 foot layer of gravel capped by in-situ soil will prevent both burrowing macro-organisms and most vandalism and looting. However, if the individuals doing the vandalism or looting are determined, a tougher protection layer may be required. If so, a thin weak mortar layer should be used. In the Rose, a 50 mm weak lime-sand (1:6) mixture was found to be effective. Because the protective layer should be able to be removed in case of re-excavation care should be taken not to design a mixture that may be too difficult to remove.

#### 4.7.6.3 Protection against construction impacts

Often, the reason for starting a reburial project is in preparation for construction on the land. If so, after the completion of the reburial project, the construction activities will start. This may result in vibrations, impact loads from dropping material, moving loads from heavy equipment, or other potentially damaging actions. However, only the archaeological material near the surface is affected. An artifact assemblage that is not sensitive to load (for example, one comprised mostly of metallic artifacts) should not be at high risk for impact based damage, although there may be damage to the archaeological context. The placement of a protection layer is recommended if the archaeological material is sensitive to load ( $S_L \geq 1$ ) and a significant percentage of the assemblage (30 % or over) is located in the upper 3 feet of the reburial system. The inclusion of a protection layer is also recommended if there is reason to believe that activities at the surface may damage the reburial system.

In these cases, a thin (50 mm) layer of weak mortar like the one installed at the Rose is recommended. This layer should be able to be removed easily in case of re-excavation. The protection layer can serve as a cap for the reburial, or it can be capped by in-situ soil.

#### 4.7.6.4 Protection against root penetration

Unchecked vegetation growth is the principal cause of damage to the archaeological material in reburied sites (Demas 2004). The case of the Laetoli hominid trackway in northern Tanzania (Demas et al. 2003) is a prominent example of a reburied site being damaged due to deep rooted vegetation.

Geomembranes have been found to be very effective against root penetration (Kavazanjian 2004). However, as they are impermeable they are not appropriate for use in sites in which the free transport of water and/or vapor through the reburial system is desired. If a geomembrane is used, Mora (1986) recommends that they never be placed directly in contact with an artifact. If a permeable layer is required, then geotextiles can be impregnated with both biocides and herbicides to act as a barrier to root penetration (Kavazanjian 2004). An herbicide impregnated geotextile was the solution employed at the Laetoli trackway. However, if a geotextile will be the primary barrier to root penetration, it should be accompanied by a regular removal of deep rooted vegetation at the site (Kavazanjian 2004).

#### 4.7.7 Separation and Filtration layers

Oftentimes, it is necessary to include a separation marker in a reburial system. This can be for a multitude of reasons (e.g. marking archaeological excavation levels, separating elements in the reburial system, avoid co-mingling of soils, marking where the

archaeological layer starts). It has been common practice in the U.K. to use commercially available sheeting product (i.e. Visqueen) for separation purposes (Goodburn-Brown and Hughes 1996). Geotextiles can also be used for separation purposes, and are a superior alternative to plastic sheeting (Kavazanjian 2004). The reason for this is two-fold. First, it is that customary to place a layer of sand on top of the geotextile before backfilling. This layer is customarily 6 inches thick. This minimizes the potential for voids which prevents moisture accumulation and biological activity. Secondly, geomembranes (plastic sheeting products) have been found to adhere to artifacts in various opportunities, and thus should never be placed in direct contact with the archaeological material (Mora 1986). Because plastic sheeting products are often impermeable, if groundwater must flow unimpeded a geotextile is recommended. A needle-punched non-woven geotextile is preferable for separation applications because of its greater flexibility to conform to uneven surfaces and greater cushioning ability (Kavazanjian 2004). However, if reinforcement is needed a woven geotextile should be used as they have greater tensile strength.

A low cost alternative for separation application is the use of natural soil horizons. Often, a layer of chemically inert, well-graded, pure sand is used for this purpose. Because this is a material with high demand in the glass-making industry, it may not always be available at a low cost. However, there have been studies to evaluate the suitability of other sands (Canti and Davis 1999). Another problem is the migration of soil particles from one layer to the other due to the flow of groundwater. If soil particle migration is found to be a problem in the fine sand separation layer, gravel can be used in its place. A small amount of fines can also reduce soil migration issues, however as fines can modify the chemical properties of the soil, care must be used before introducing them into the reburial system.

Soil migration can also be a problem even if a natural separation layer is not used. Soil particles from the natural soil, or from borrow soil, can migrate, either to other parts of the reburial or be washed away entirely. Soil migration can be prevented by preventing or reducing the speed of the water flowing through soil, or preventing movement of the soil particles.

Reducing the speed of the water through the soil can be achieved by introducing a hydraulic barrier in the reburial system. A material with hydraulic conductivity lower than the adjacent material will slow down the water, which means that there will be a decrease in the size of soil particles it will be able to carry. A geosynthetic material with a low hydraulic conductivity can then act as a separation layer, but also to prevent migration of soil particles in the soil. Although all soil particles can be carried away given a high enough water speed, certain soils are more resistant than other. Gravels (both well and poorly graded), silty gravels, and clays (high and low plasticity) will generally be more resistant to soil migration (Daniel and Koerner 1993).

To prevent the movement of soil particles through the soil, a filtration layer can also be used. Filtration layers can be either natural materials (fine sand is commonly used) or geosynthetics. A filtration layer should allow free passage of water while preventing the movement of soil particles.

If the filtration layer is to be constructed with soil, certain requirements for the filter material must be met. In order for the filter material to prevent significant penetration from the adjacent soil, the particle diameter at which 85 % of the adjacent soil is finer ( $D_{85,soil}$ ) must be 4 to 5 times larger than the particle diameter at which 15 % of the filter soil is finer

( $D_{15,filter}$ ) (Daniel and Koerner 1993). Filter material which satisfies that condition ( $D_{15,filter} \leq (4 \text{ to } 5)D_{85,soil}$ ) should prevent migration of particles from the adjacent soil layer.

Geotextiles will also prevent the transport of soil particles while allowing the movement of water across the boundary. The apparent opening size (AOS) of a geotextile will determine what size of soil particle it is able to retain. A geotextile with an AOS of 75 will retain most soils, including fines (Kavazanjian 2004). Carroll (1983) recommends a more restrictive approach. The necessary AOS can be computed as:

$$AOS_{reqd} < (2 \text{ or } 3)d_{85}$$

Where  $d_{85}$  is the soil particle size diameter for which 85 % of the sample is finer. A composite filtration system, combining a geotextile with a layer of filter material overlying it is also possible and should be employed if the reburial system is at high risk of soil migration.

A geosynthetic filtration system must allow the free passage of liquid through the fabric, retain the soil on the upstream site, and must have long term soil-to-fabric flow compatibility to prevent clogging. As geosynthetic materials can be relatively thick and compressible, the thickness of the material is included in the permeability calculations.

This property, called permittivity, is defined as:

$$\psi = \frac{k}{t}$$

Where  $\psi$  is the permittivity of the geosynthetic,  $k$  is the cross-plane permeability of the geosynthetic, and  $t$  is the fabric thickness. The required permittivity of a geosynthetic can be computed as:

$$\psi_{reqd} = \frac{q}{(\Delta h * A)}$$

Where  $q$  is the cross-plane flow rate of the geosynthetic,  $\Delta h$  is the liquid head from the bottom of the geosynthetic, and  $A$  is the filtration area. The allowable permittivity of a geosynthetic material can be computed as:

$$\psi_{allow} = \frac{\psi_{ult}}{RF_{SCB} * RF_{CR} * RF_{IN} * RF_{CC} * RF_{BC}}$$

Where  $\psi_{ult}$  is the ultimate permittivity of the geosynthetic (provided by the manufacturer), and  $RF_{SCB}$ ,  $RF_{CR}$ ,  $RF_{IN}$ ,  $RF_{CC}$  and  $RF_{BC}$  are reduction factors for soil clogging and blinding, creep reduction of void space, adjacent materials intruding into geosynthetic void space, chemical clogging, and biological clogging respectively.

#### **4.7.8 Determining monitoring plan and finalizing the design**

##### 4.7.8.1 Monitoring

After reburial of a site has been undertaken, a monitoring and maintenance regime must be considered to ensure the preservation of both the archaeological remains and the integrity of the reburial system. Reburied archaeological material can be damaged by compression of the archaeological remains due to an applied load due to overlying construction or construction activities such as backfilling. (Shilston and Fletcher 1998). Changes in

groundwater and soil chemistry can also accelerate the deterioration of the archaeological material (Johnsen 2009).

Mathewson et al. (1992) recommend that reburial systems should be monitored to ensure that the conditions at the site are conducive to the preservation of the archaeological remains. However, monitoring of reburial projects is relatively rare. Johnsen (2009) only discusses 2 cases (the Rose Theatre and the second Shardlow boat) where a monitoring regime was undertaken. Johnsen also states that in-ground monitoring of reburied archaeological sites has not been undertaken in Norwegian reburials.

Thorne (1991) states that there are various levels of monitoring. At its lowest level, monitoring consists of *“little more than regularly ascertain the condition of the surface of the site and have those observations recorded”*. The next level is for *“site condition observations to be made, problems of stability noted, and some effort will then be made to rectify any problems”*. Finally, the most complex level of monitoring entails determining the condition of the buried archaeological material. As the material will no longer be accessible, a monitoring plan needs to be decided upon in the design phase so as to accommodate any monitoring equipment necessary.

#### 4.7.8.2 Existing monitoring programs

The Rose Theatre has been continuously monitored since reburial. Figure 4.25 shows the monitoring program that was undertaken, which was designed by Huntings Technical Services. The monitoring program consisted of installing gypsum resistance cells to measure moisture content at various depths in the sand and the top of the archaeological



layer, and installing various dipwells to record the height of the water table above the archaeological remains.

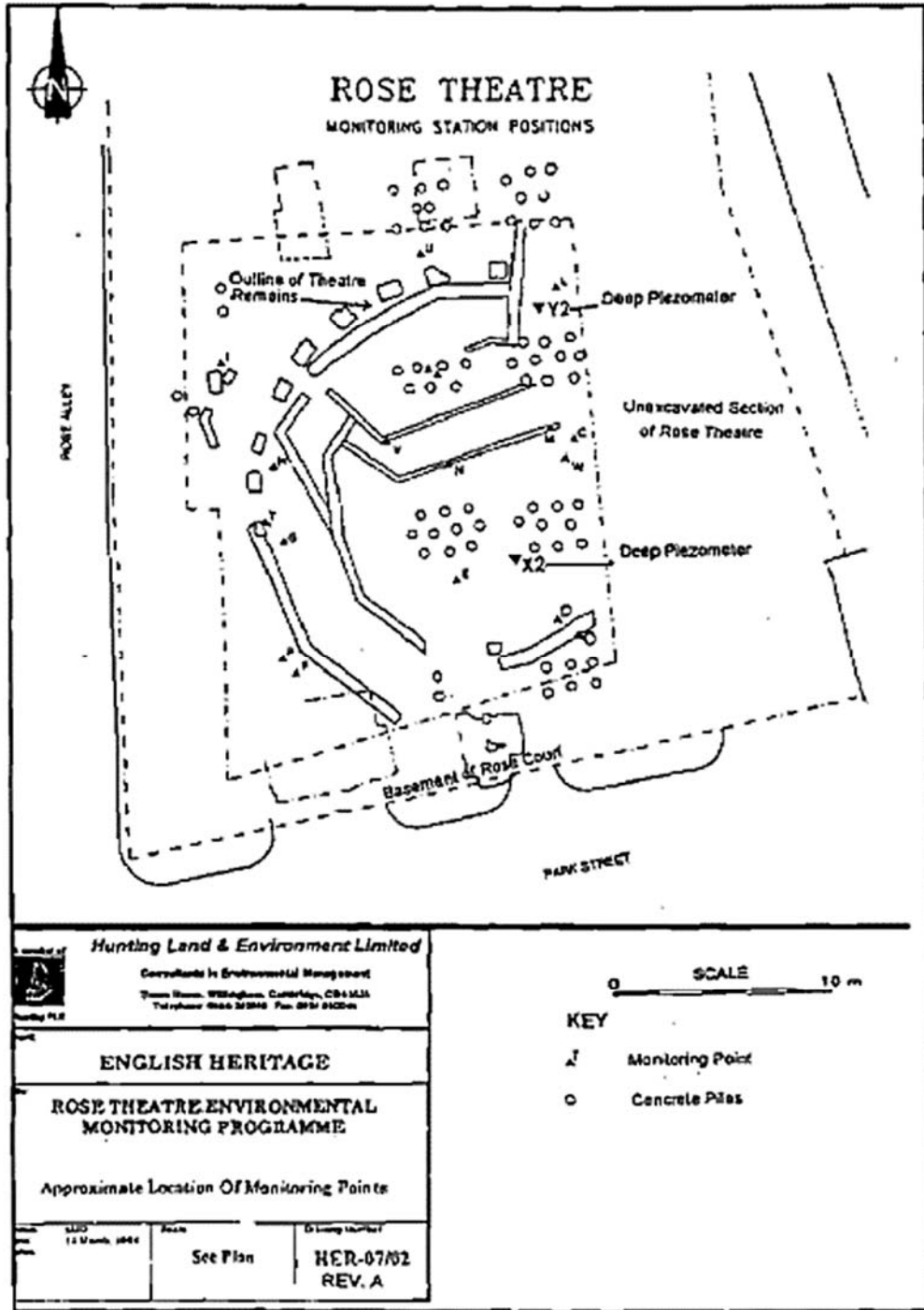

Figure 4.25 Monitoring plan at the Rose Theatre (from Corfield 2004)

Measurements of pH, redox, dissolved oxygen, conductivity, and temperature were taken monthly. Water samples were also taken twice from the dipwells, once at the time of installation and once more between then and 2004 (Corfield 2004), to perform a full chemical analysis of the groundwater. After replacing the resistance cells (which had reached the end of their life cycle) in 1994, 1996, and 2000, the cells were replaced with a time domain reflectometry system. The advantages of changing are that moisture contents could now be measured at any depth in the reburial system, and that the readings were more accurate near saturation conditions. However, Corfield cites that the probes need to be adjusted for the specific soils in which they are to be used, although this should not be a disincentive for long term reburial systems.

Monthly monitoring of the site corroborated the conditions at the site were in the desired range. As the reburial system progressed from a temporary to a permanent solution, the monitoring data became more and more relevant for ensuring the continued survival of the buried archaeological material.

The second Shardlow boat reburial project also included a monitoring system. The system was comprised of vibrating wire piezometers installed at the stern, prow, and middle of the boat embedded in the soil upon which the boat is resting. Additionally, redox measuring probes were installed in the same places and a small reservoir in the boat was connected to the outside through plastic tubing so that water samples could be acquired. The instrumentation was connected to the monitoring equipment which was placed in a small hut nearby.

Although a monitoring plan had been accounted for since the beginning of the project, the monitoring activities were hampered by staff shortages and equipment failures. It was planned that until stable conditions at the boat had been established, weekly moisture content and redox readings would be taken. However, some periods only have a monthly reading. Another issue with the monitoring program is that although monitoring was agreed to be undertaken from the early stages of the project, no targets were set for the data to demonstrate that the reburial system was successful, other than the provision that the site stay waterlogged and in a reducing environment.

#### 4.7.8.3 Important properties to monitor

The goal of a monitoring system is to be able to verify that conditions favorable for the preservation of the buried archaeological deposits are present in the reburial system. However, two fundamental problems need to be addressed for in-situ preservation efforts to be successful. First, there needs to be research focused towards determining the optimum burial conditions to inhibit the physical, chemical, and biological decay processes of archaeological material. Second, technology for the long term monitoring of archaeological remains must be developed (Corfield 1996).

Currently, monitoring of reburied archaeological sites is performed with both above ground observations and in ground instrumentation. Sites are periodically revisited, and the stability of the site is determined through simple observation as well as any maintenance needs, such as vegetation control. In ground monitoring has focused on indicators of environmental damage, such as moisture content, pH, redox potential, dissolved oxygen, electrical conductivity, and temperature. However, monitoring of mechanical causes of damage such as applied load, settlement, and vibrations is also possible. The monitoring

program of each site will be dependent on the artifact assemblage, and the decay processes of the archaeological material present need to be understood in order to determine which conditions to monitor, and what the acceptable range is. Table 4.16 summarizes common parameters which are monitored, and the archaeological material susceptible to the associated damage sources.

Table 4.16 Common monitoring parameters and susceptible archaeological material.

Parameter to monitor	Monitoring technique	Susceptible Materials (based on Mathewson 1988)	
Environmental	pH	Sampling wells, in-ground pH probes	Animal bones, shell, granular lithics, soil attributes, metals, isotope content, plants
	Redox potential	Sampling wells, in-ground redox probes	Animal bones, shell, plants, metals
	Dissolved O <sub>2</sub>	Sampling wells, in-ground O <sub>2</sub> probes	Animal bones, shell, plants, charcoal, crystalline lithics, ceramics, archaeological features, soil attributes, metals, isotope content
	Electrical conductivity	Sampling wells, in-ground conductivity probes	Animal bones, shell, plants, charcoal, crystalline lithics, ceramics, archaeological features, soil attributes, metals, isotope content
	Temperature	Sampling wells, in-ground temperature probes	Animal bones, plants, charcoal, metals, context, isotope content
	Moisture content	Sampling wells, piezometers, time domain reflectometry	Animal bones, shell, plants, charcoal, crystalline lithics, ceramics, archaeological features, soil attributes, metals, isotope content, topography
Mechanical	Vegetation overgrowth	Direct observation	All
	Compression	Embedment earth pressure cells	Animal bones, shell plants, charcoal, ceramics, archaeological features, soil attributes, context, topography
	Movement	Extensometers, deformation gages	Charcoal, archaeological features, soil attributes, context, topography

#### 4.7.8.4 Environmental damage monitoring

Monitoring for environmental damage is primarily focused on ensuring that the desired conditions for preservation have taken place in the reburial environment. Monitoring of indicators of decay processes (such as dissolved oxygen) is also possible. As decay processes for archaeological material vary, the monitoring program needs to be tailored to the site. The artifact decay matrix (Mathewson and Gonzalez 1988) can be used for guidance when designing the monitoring program.

**pH:** Changes in pH can be especially deleterious to certain types of archaeological material. Materials which have high calcium content (such as bones and shell) can quickly degrade in acidic environments, while plant material degrades in a basic environment.

Metals are also susceptible to acidic environments (Mathewson and Gonzalez 1988). The monitoring of pH can be achieved by testing groundwater samples taken from the site, via a sampling well or similar, or by in ground instrumentation (such as in the Rose).

**Redox potential:** Reduction-oxidation reactions can often cause damage to the archaeological material, especially metals and organics. Often, reburial environments will be required to have an oxidizing environment to prevent bacterial colonies from forming (Corfield 2004). Reducing environments are also a benign environment for the conservation of metals (Rimmer and Caple 2008). Redox potential can be monitored through the use of wells or in ground probes.

**Dissolved oxygen:** Dissolved oxygen is used as an indicator of biological activity. Most microorganisms require the presence of oxygen to grow; an anoxic environment is then conducive to the preservation of the remains. However, some bacteria can grow in a reducing environment (Caple 2004; Corfield 1996). Organic materials, especially wood, are especially susceptible to damage due to microorganism activity. Dissolved oxygen can be monitored through the testing of samples acquired through a well, or by in ground monitoring. However, the sampling process may introduce some oxygen into the sample, giving a false reading (Corfield 2004).

**Electrical conductivity:** Electrical conductivity is measured as an indicator of dissolved salt content in the reburial environment. As salts can travel through the system, crystallization of these salts in the archaeological layer can severely damage the archaeological material. Salt crystallization affects archaeological material by both

obscuring the surface, and by starting chemical reactions. Electrical conductivity can be measured both by testing samples acquired through a well or by in ground probes.

**Temperature:** Extremes in temperature must be avoided in the reburial environment. High temperatures lead to increased biological activity which can severely damage organic archaeological material. Low temperatures can lead to the freezing of the deposits, and to freeze-thaw cycles which is one of the most damaging conditions to archaeological material (Mathewson and Gonzalez 1988). Temperature is best measured through the use of in ground instrumentation, as the sampling process may impact the temperature, giving a false reading. Commonly, temperature will be measured using a thermistor, thermocouple, or resistance temperature device (RTD). Figure 4.26 summarizes the features of these devices.

Feature	Thermistor	Thermocouple	RTD
Readout	Digital ohmmeter or multimeter	Thermocouple reader	Wheatstone bridge with millivolt scale
Sensitivity	Very high	Low	Moderate
Linearity	Very poor	Fair	Fair
Accuracy	High	Moderate	Very high (but may be reduced by lead wire effects)
Stability	Excellent	Good	Excellent
Type of lead wire	Two-conductor	Special (bimetal)	Three-conductor
Repairability of lead wire	Straightforward	Less straightforward (can cause errors)	Straightforward
Temperature range	Wide	Wide	Wide
Rapidity of response	Rapid	Rapid	Rapid
Applicability for instrument temperature corrections	Preferred	Possible	Possible
Suitability for automatic data acquisition	Fair	Excellent	Good

Figure 4.26 Comparison among transducers for remote measurement of temperature in geotechnical engineering (from Dunnicliff 1993)

**Moisture content and groundwater table position:** Moisture content is often monitored, as the presence of water is the catalyst for many types of environmental damage. Furthermore, certain archaeological material (such as archaeological wood) need to be kept at a constant moisture to prevent damage. Due to this, knowing the precise location of the groundwater table is often critical to ensure adequate preservation of the reburied archaeological material. Sampling wells are an effective way of measuring groundwater table location. Piezometers are an attractive alternative as they are efficient, cost effective, and require minimal installation. Moisture content in the soil can also be measured using in ground instrumentation, as was done in the Rose. In the Rose, gypsum resistance cells were found to work adequately, but required replacing at regular intervals (Corfield 2004). Because of this, a time domain reflectometry system was installed to monitor moisture content at different points in the reburial system. However, the elevated cost of the system restricts its use to high profile, permanent reburial systems (Corfield 2004).

#### 4.7.8.5 Mechanical damage monitoring

Traditionally, monitoring programs have focused on environmental damage to the archaeological material. However, monitoring of mechanical damage sources is also possible through geotechnical instrumentation and can be done in a cost effective manner.

**Vegetation overgrowth:** Unchecked vegetation growth is the primary cause of damage to reburied archaeological sites (Demas 2004). Sites need to be periodically checked to prevent site loss due to vegetation. As reburied sites are commonly covered in shallow rooted vegetation to prevent erosion, growth of plants which do not pose a threat to site integrity should be encouraged. However, regular maintenance may be needed to ensure that deep rooted vegetation which could damage both the archaeological material and the

reburial system is removed. Monitoring of vegetation is performed through direct observation.

Factor	Description of Error	Correction Method <sup>a</sup>
Aspect ratio (ratio of cell thickness to diameter)	Cell thickness alters stress field around cell	Use relatively thin cells ( $T/D < 1/10$ )
Soil/cell stiffness ratio (ratio of soil stiffness to cell stiffness)	May cause cell to under- or overregister Error will change if soil stiffness changes	Design cell for high stiffness and use correction factor
Size of cell	Very small cells subject to scale effects and placement errors Very large cells difficult to install and subject to nonuniform bedding	Use intermediate size of cell: typically 9–12 in. (230–300 mm) diameter <sup>b</sup>
Stress-strain behavior of soil	Measurements influenced by confining conditions	Calibrate cell under near-usage conditions <sup>b</sup>
Placement effects	Physical placement and backfilling causes alteration of material properties and stress field around cell	Use placement technique that causes minimum alteration of material properties and stress field <sup>b</sup>
Eccentric, non-uniform, and point loads	Soil grain size too large for cell size used Nonuniform bedding causes nonuniform loading	Increase active diameter of cell <sup>b</sup> Use hydraulic cells with grooved thick active faces in preference to other types <sup>b</sup> Take great care to maximize uniformity of bedding <sup>b</sup>
Proximity of structures and other embedded instruments	Interaction of stress fields near instruments and structure causes errors	Use adequate spacing
Orientation of cell	Changing orientation while placing fill over cell causes reading change	Use placement methods that minimize orientation changes Attach tiltmeters to cell
Concentrations of normal stress at edges of cell	Causes cell to under- or overregister, depending on stiffness of cell relative to soil	For diaphragm cell, use inactive stiff edge ring to reduce sensitive area ( $d/D \approx 0.6$ ) <sup>b</sup> For hydraulic cell, use grooved thick active face and thin layer of liquid
Deflection of active face	Excessive deflection of active face changes stress distribution around cell by arching	Design cell for low deflection: for diaphragm cell, diaphragm diameter/diaphragm deflection at center $> 2000$ – $5000$ ; for hydraulic cell, use thin layer of liquid <sup>b</sup>
Placement stresses	Overstressing during soil compaction may permanently damage cell	Check cell and transducer design for yield strength (hydraulic cells with pneumatic transducers have high overload capacity) <sup>b</sup>
Corrosion and moisture	May cause failure of cell by attacking cell materials	Use appropriate materials and high-quality waterproofing <sup>b</sup>
Temperature	Temperature change causes change of cell reading	Design cell for minimum sensitivity to temperature; if significant temperature change is likely, measure temperature and apply correction factor determined during calibration <sup>b</sup>
Dynamic stress measurements	Response time, natural frequency, and inertia of cell cause errors	Use appropriate type of cell and transducer, together with dynamic calibration <sup>b</sup>

<sup>a</sup> $D$  = cell diameter;  $T$  = cell thickness;  $d$  = diaphragm diameter.

<sup>b</sup>Applies also to contact earth pressure cells. See Section 10.3.2.

Figure 4.27 Major factors affecting measurements with embedment earth pressure cells (from Dunnycliff 1993).



**Compression:** Compression of the archaeological material due to an applied load is often a concern. Excessive load on the archaeological layer can lead to damaging of the archaeological material, and induce settlement of the archaeological layer. If the reburial system was designed assuming that the archaeological layer would be subjected to a maximum stress (or no stress at all) the load must be monitored to ensure that the reburial system is meeting that goal. Total stress in soil can be measured through embedment earth pressure cells. However, as the presence of the cell and the installation method significantly affect the cell's surrounding, it is usually impossible to measure total stress with great accuracy (Dunncliff 1993). Figure 4.27 summarizes the possible sources of error and how to correct them.

**Movement:** Movement in the reburial system is often monitored to prevent destroying the context of the archaeological layer. Because the spatial relations between elements in the archaeological assemblage can often tell us more than the elements themselves, it is often critical to prevent deformation in the reburial system. Settlement can also be a problem, both from an archaeological point of view (loss of contextual information), but also from an engineering point of view as excessive settlement (total or differential) may constitute failure. Deformation in the soil mass can be measure in various directions, both at the surface and below. Extensometers and deformation gages are often used as they are cost effective and can be easily placed. Figure 4.28 summarizes the different available geotechnical instrumentation for measuring deformation, both above and below the surface.

Category	Type of Measured Deformation					
	↔	↑↓	↗↘	⤵	±	∓
SURVEYING METHODS	•	•	•		•	
Optical and other methods						
Benchmarks						
Horizontal control stations						
Surface measuring points						
SURFACE EXTENSOMETERS	•	•	•		•	
Crack gages						
Convergence gages						
TILTMETERS				•	•	•
PROBE EXTENSOMETERS	•	•	•			•
Mechanical heave gage						
Mechanical probe gages						
Electrical probe gages						
Combined probe extensometers and inclinometer casings						
FIXED EMBANKMENT EXTENSOMETERS	•	•	•			•
Settlement platform						
Buried plate						
Mechanical gage with tensioned wires						
Gages with electrical linear displacement transducers						
Soil strain gage						
FIXED BOREHOLE EXTENSOMETERS	•	•	•			•
Single-point and multipoint extensometers						
Subsurface settlement points						
Rod settlement gage						
INCLINOMETERS	•	•	•	•		•
TRANSVERSE DEFORMATION GAGES	•	•	•			•
Shear plane indicators						
Plumb lines						
Inverted pendulums						
In-place inclinometers						
Deflectometers						
Borehole directional survey instruments						
LIQUID LEVEL GAGES		•				•
Single-point and multipoint gages						
Full-profile gages						
MISCELLANEOUS DEFORMATION GAGES						
Telltails	•	•	•		•	•
Convergence gages for slurry trenches	•	•	•		•	•
Time domain reflectometry	•	•	•		•	•
Fiber-optic sensors	•	•	•		•	•
Acoustic emission monitoring	•	•	•		•	•

Key: ↔ horizontal deformation      ↗↘ axial deformation (↔ or ↑↓ or in between)      ± surface deformation  
↑↓ vertical deformation      ⤵ rotational deformation      ∓ subsurface deformation.

Figure 4.28 Categories of instruments for measuring deformation (from Dunnicliff 1993)

#### 4.7.8.6 Finalizing the design

After each layer has been designed, or removed, the design of the reburial system must be finalized. Because of the versatility of geosynthetics, a layer designed for one purpose could serve multiple purposes. For example, a GCL could function both for cushioning and as an infiltration barrier. Thus, once the reburial system elements have been designed, redundant layers should be identified and removed. However, the removal of an element should be made only after a careful decision, and only if it can be guaranteed that it was redundant. The reburial system should be capped by a 2 foot thick soil layer that is able to support vegetation. If the reburial system does not include a protection layer, and the fill material is able to promote shallow rooted vegetation, the cap is not necessary.

Ultimately, the design should be reviewed by both an engineer and an archeologist. Reburial system performance is evaluated on both archaeological and engineering fronts. Firstly, the design should be able to withstand the engineering necessities of the land use. This may require the reburial system to bear the weight of foundations, support roads and embankments, or other functions required by the post-burial land use. Secondly, the reburial system needs to effectively protect the archaeological material buried it. Because examining the archaeological material under a reburial system is impossible without excavation, monitoring is essential to ensure its continued survival

## CHAPTER 5 DESIGN EXAMPLES

### 5.1 Pre-design considerations

The reburial of an archaeological site is the result of a planning process composed of three stages: preparation, assessment, and response (Demas 2004). Throughout the entire process, both archaeologists and engineers should work together to meet both the conservation and the engineering performance goals required by the project.

**Preparation:** This is the stage where information about the site is collected, and a baseline can be established. Some of the questions that need to be addressed by the archaeological staff are (Demas 2004):

- a.) What is known about the site?
- b.) Where are the gaps in research?
- c.) What is the history of interventions on the site (excavation, conservation, and use)?

The engineering questions that need to be addressed are:

- a.) What will be the proposed land use?
- b.) What is the existing infrastructure at the site?

Both sets of questions should be addressed by trained professionals in the field, relying on the input of one another. The information collected in this step will be used in the design process later.

**Assessment:** The assessment stage involves taking stock of the site by analyzing the context of the resource. This stage is critical for determining whether reburial (or another conservation option) is the optimal solution for the site. The conservation scheme needs to be a sustainable solution. During assessment, the significance of the site, its physical condition, and the management context are analyzed (Demas 2004).

These questions can be analyzed from both an archaeological and an engineering point of view. Some of the questions (both from an archaeological and engineering standpoint) that need to be answered are presented in Table 5.1.

During this stage is when the detailed information necessary for the design of the conservation treatment is gathered. Providing information on the site contents and condition should be one of the primary goals of the archaeological staff. However, unless the site has been previously excavated and there is a detailed inventory, this is an almost impossible task. For this reason, the archaeologist should provide as much information as is available, and use his or her expertise to provide an estimation of the unknown archaeological material. This can be done by using historical sources, or by extrapolating from data gathered in exploratory excavations.

Table 5.1 Considerations to be made during the assessment stage (based on Demas 2004).

	Site significance	Physical condition	Management context
Archaeological	Why is this site important? Who values it? What benefits accrue from it?	What is the condition of the site or structure? What are the threats and causes of deterioration?	What legal, administrative, financial conditions pertain? What social, political, and economical factors may affect the conservation and management of a site?
Engineering	Why is this plot of land significant? Is it possible to find a new site? Is it economically feasible to include a conservation treatment in the project budget?	What is the soil stratigraphy? What are the soil properties? What is the subsurface hydrology of the site?	Will the future land use change in ways that may affect the conservation of the archaeological material? Will there be budget allowed for monitoring and maintenance? What are the demands placed on the site?

**Response:** In this stage, the optimal conservation option is chosen and executed. If the alternative chosen is reburial, then a reburial cover can be designed using the DAISEE guidelines. In addition, Demas (2004) states that the considerations presented in Table 5.2 may apply.

Table 5.2 Considerations that may apply if reburial is chosen as the conservation options (Demas 2004).

Stakeholder considerations	Technical conservation considerations	Management considerations
Documentation and publication of the research performed Research needs of the project Display/exhibition of the remains Stakeholder involvement in the project Popular and scholarly publication Networking lecturing Media presence Advisory group	Research and testing needs Type of remains to be protected Duration of reburial Depth of fill Horizon markers Bulk fill materials Specialized fill materials Differential fills Erosion control and drainage Vegetation control Post-reburial use Long-term monitoring	Costs Staffing Post-reburial maintenance needs Security Legal implications Political constraints

Besides the considerations in Table 5.2, other questions related to the post-reburial use of the land must be answered. If there is to be overlying construction on the site, the integrity of the project must be ensured. To do so, engineering considerations (such as soil bearing

capacity and compressibility) will need to be evaluated as part of the reburial system and the overlying construction.

## 5.2 Design process

The design process for a reburial system using the DAISEE guidelines is presented in Figure 5.1. This design process is to take place during the response stage, after the necessary information about the site has been collected, and reburial has been chosen as the optimal conservation strategy.

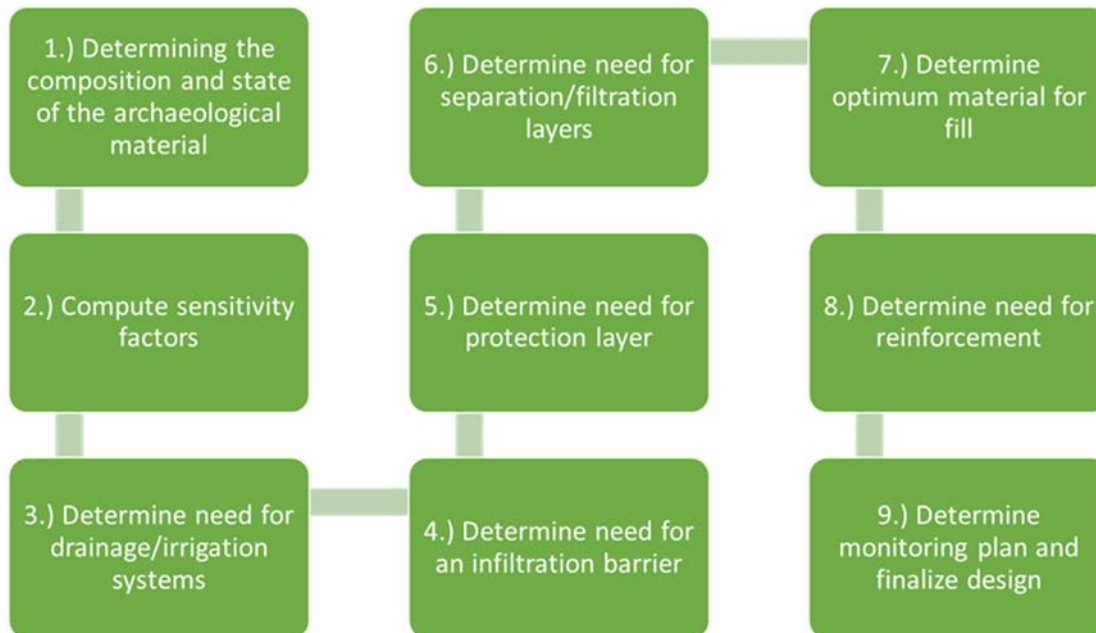

Figure 5.1 Design process for a reburial system using the DAISEE guidelines

Using the DAISEE guidelines is a sequential design process. Each layer is designed independently, according to the necessities placed on the site by the archaeological material and the post-reburial land use. The design is then evaluated, and redundant layers are eliminated. However, because there is a wide range of possible site and archaeological

material conditions, the reburial system recommended by DAISEE should be evaluated by both the engineer and archaeologist at the site to ensure it will meet both archaeological and engineering performance goals.

### 5.2.1 Site Sensitivity Equation Example

Given an imaginary archaeological site, which has an assemblage ‘A’, we can calculate both the sensitivity factor, and the prioritized sensitivity factor. The assemblage is presented in Table 5.3. This information should be compiled by a trained archaeologist, or other historical expert. It must be noted that because determining the exact composition and state of a real world assemblage is not usually possible, some assumptions and estimates are necessary. Procuring a representative sample of the assemblage and extrapolating assemblage composition and condition from that sample is recommended, although the final decision should be taken by the archaeological expert.

Table 5.3 Assemblage present in an imaginary archaeological site.

Assemblage A			
Artifact	Percentage in Assemblage (by unit count)	Condition	Archaeological Value
Wood	4	50 % original mass	0
Bone	65	70 % original mass	2
Metal	10	90 % original mass	1
Glass	11	6 shards, 1 glass, 1 bottle	0
Ceramic	10	13 sherds, 2 small plates and a large vase	0

Given the information in Table 5.3, sensitivity factors for load (1.07), pH (1.04), redox (0.87) and microbial activity (0.82) can be computed. These values let us know that given



this particular assemblage, load is the controlling design factor for this reburial system. Because load is the controlling factor, the reburial system will likely be a mechanical damage preventing system. However, as the final design will be subject to other factors (current and expected conditions at the site, possible land use) this should serve only as a guidance for design. Because the sensitivity factor for pH is a close second, these other factors may push the design towards an environmental damage preventing reburial system.

Table 5.4 Sensitivity factors for load, pH, redox, and O<sub>2</sub>.

	DI*C*P	Dph*C*P	Dredox*C*P	Do2*C*P
Wood	0.02	0.04	0.02	0.08
Bone	0.74	0.93	0.74	0.74
Metal	0.01	0.07	0.11	0.00
Glass	0.18	0.00	0.00	0.00
Ceramic	0.13	0.00	0.00	0.00
S	1.07	1.04	0.87	0.82

Because Table 5.3 presents archaeological value factors for assemblage 'A', it may be more appropriate to use the prioritized site sensitivity equation in order to give more importance to the preservation of bone and metal. The prioritized factors are presented in Table 5.5.

Table 5.5 Prioritized sensitivity factors for load, pH, redox, and O<sub>2</sub>.

	Ci	ψ	Ti	DI * Ti	Dph*Ti	Dredox*Ti	Do2*Ti
Wood	2	0.5	0	0	0	0	0
Bone	1.43	0.65	1.3	1.04	1.3	1.04	1.04
Metal	1.11	0.5	0.5	0.05	0.3	0.5	0
Glass	1.63	0.5	0	0	0	0	0
Ceramic	1.25	0.5	0	0	0	0	0
S'	-	-	-	2.16	2.64	1.96	1.86

By using the prioritized factors, we can see that all the sensitivity factors have been increased by an average of 126%. The sensitivity factors for pH (2.64, 155 % increase),

redox (1.86, 126 % increase), and O<sub>2</sub> (1.96, 125 % increase) had large increases, followed by load which had a more modest, yet still robust, gain (2.16, 101 % increase). However, using the prioritized sensitivity equation the controlling factor becomes pH, followed by load. This is because the conservation of bone (whose main mechanisms of decay are controlled by pH and applied load) was prioritized over other types of material. This, contingent on conditions at the site, land use, and other factors may guide the reburial system design towards protecting the assemblage from environmental damage. In this case, because bone is sensitive to all conditions considered, all sensitivity factors increased in value. However, if the conservation of another type of material is prioritized, only the sensitivity factors for which that material is susceptible to damage will increase.

### 5.2.2 Design steps

Table 5.6 presents the input, output, and design constraints for reburial systems designed using the DAISEE guidelines.

Table 5.6 Inputs, outputs, and design constraints for the DAISEE guidelines

Input	Output	Design constraints
Historical documents	Infiltration barrier	Depth of archaeological layer
Exploratory archaeological testing results	Protection layer	Depth of construction
Inflow rate to the archaeological layer pre and post reburial	Drainage/Irrigation system	Properties of the soil in the archaeological layer
Load type	Optimum fill material	Budget
Load magnitude	Separation/reinforcement layers	Installation time
Load location and distribution	Reinforcement of the reburial system	Use of underground space
Groundwater table location and fluctuation		Available plan area

The DAISEE approach follows these steps:

#### Step 1: Determining the composition and state of the archaeological material

Input: Historical documentation, results of exploratory testing

Output: Artifact assemblage composition and condition, conservation priorities

Is there archaeological material at the site which needs preservation?

If no, then backfill open excavations as needed

If yes, then estimate archaeological assemblage composition and condition to be preserved by reburial and tabulate the results as showed in Table 5.3.

## Step 2: Compute sensitivity factors

Input: Artifact assemblage composition and condition,

Output: Sensitivity factors (prioritized or not), Environmental number, mechanical number

Using the sensitivity equation, calculate sensitivity factors for the assemblage. If conservation of one type of material is to be favored over another, then prioritized sensitivity factors should be calculated instead.

Calculate the mechanical number ( $N_M$ ):

$$N_M = \frac{\sigma'_{post}}{\sigma_{ref}} * S_L$$

Where:  $\sigma'_{post}$  is the effective stress at the top of the archaeological layer, and  $\sigma_{ref}$  is a reference stress. The value of the reference stress is tied to the maximum past pressure at the top of the archaeological layer.

Calculate the environmental number ( $N_E$ ):

$$N_E = \frac{R_{post}}{R_{pre}} * \left( \frac{S_{pH} + S_{redox} + S_{O2}}{3} \right)$$

Where  $R_{post}$  is the expected inflow rate to the archaeological layer post-reburial, and  $R_{pre}$  is the inflow rate to the archaeological layer pre-reburial.

### **Step 3: Determine need for drainage/irrigation systems**

Input: Artifact assemblage composition and condition, conservation priorities, location of the groundwater table, fluctuations in the groundwater table

Output: Drainage or irrigation system

Is there material in the assemblage which needs to be kept in a saturated medium (S = 100%)? (For example, saturated historical wood)

If yes, then is the maximum groundwater table depth ( $D_{GWT}^{Max}$ ) higher than the depth of the archaeological layer ( $D_{arch}$ )?

If  $D_{GWT}^{Max} > D_{arch}$ , then install an irrigation system at the top of the archaeological layer. A leaky pipe system was found to be effective at the Rose, and so is the recommended alternative.

If  $D_{GWT}^{Max} \leq D_{arch}$ , then no irrigation system is necessary

If no, then is there material in the assemblage that needs to be kept in a dry condition (for example, dry archaeological wood)?

If yes, then is the minimum groundwater table depth ( $D_{GWT}^{Min}$ ) lower than the depth of the archaeological layer?

If  $D_{GWT}^{Min} \leq D_{arch}$ , then a drainage layer is required. Calculate required flow rate, and select appropriate material (either sand or a geonet). Vertical drainage should be included in the design.

If  $D_{GWT}^{Min} > D_{arch}$ , then no drainage system is required

#### **Step 4: Determine need for an infiltration barrier**

Input: Environmental number

Output: Infiltration barrier

Based on  $N_E$ , decide which infiltration barrier is best suited to the project.

If  $N_E \leq 1$ , then no infiltration barrier is required

If  $1 < N_E < 2.5$ , then use a GCL

If  $N_E \geq 2.5$ , then use a composite liner system

#### **Step 5: Determine need for protection layer**

Input: Load sensitivity factor, artifact assemblage and condition, site conditions

Is the site in danger due to damage caused by:

Erosion? If so, include a hard surface covering, or cap that will promote shallow rooted vegetation growth

Vandalism or macro-organism activity? If so, include a 1 foot thick gravel layer, or a weak mortar layer

Construction impacts? If so, use a weak mortar layer

Root penetration? If so, use a root penetration barrier. Impermeable root penetration barriers are geomembranes and weak mortar layers. If a permeable barrier is needed, an herbicide impregnated geotextile accompanied by regular deep-rooted vegetation removal at the surface should be employed.

### **Step 6: Determine need for separation/filtration layers**

Input: Archaeological material composition and condition, soil gradation

Output: Separation and filtration layers

Is soil migration or movement of particles through the reburial system an issue?

If yes, then design a filtration layer to prevent movement of material through the reburial system. The drainage layer can be made of sand, or a geotextile may be used

If not, is there a need for separation between components of the reburial system, or between the reburial system and the archeological material?

If yes, then does the separation layer need to be permeable?

If yes, then use a needle-punched, non-woven geotextile

If no, use a geomembrane or plastic sheeting product. As these should never be placed in contact directly with the archaeological material, if they are to be placed at the bottom of the reburial system, a geotextile should be placed below it.

### Step 7: Determine optimum material for fill

Input: Archaeological material and assemblage, sensitivity factors, load magnitude, load location, load dimension, load type, compression index and recompression index of the archaeological soil layer

Output: Optimum fill material

Calculate fill thickness ( $t_{fill}$ ):

$$t_{fill} = (D_{arch} - D_{const}) - \sum_{i=1}^n t_i$$

Where:  $D_{arch}$  is the depth of the archaeological layer,  $D_{const}$  is the depth of construction, and  $\sum_{i=1}^n t_i$  is the sum of the thicknesses of the other components in the reburial system, for n number of components.

To determine optimum fill using fill material table:

If fill needs to be load bearing, eliminate ESCS, Expanded Clay Pellets, Vermiculite

If fill needs to be permeable, eliminate cohesive soils, EPS, CLSM

If fill needs to be impermeable, eliminate sand, gravel, ESCS, expanded clay pellets, vermiculite, wood fiber

If fill needs to be corrosion resistant, eliminate cohesive soils (unless they are found to be inert through testing), wood fiber

After all eliminations have been made, the remaining materials should be evaluated on their suitability for fill. The optimal fill should be able to meet the bearing capacity and settlement performance parameters required by the project. If reinforcement is necessary, soil (either borrow or in-situ) should be used as the fill material.

If a thick lightweight fill will be used, select an appropriate fill material and calculate fill thickness.

### **Step 8: Determine need for reinforcement**

Input: Magnitude, type, location, and dimension of the applied load to the site, fill material strength parameters, fill material compressibility

Output: Reinforcement

Is the reburial system load bearing?

If yes, is  $S_t \leq S_{allow}$ ?

If yes, is  $q_{req} \leq q_{allow}$ ?

If yes, no reinforcement is required

If no, design geotextile or geogrid reinforcement to be placed in the fill so that engineering performance goals are met

If no, design geotextile or geogrid reinforcement to be placed in the fill so that engineering performance goals are met, and check that  $q_{req} \leq q_{allow}$

If no, no reinforcement is needed



## **Step 9: Determine monitoring plan and finalize design**

Input: Previous layer design

Output: Reburial system design and monitoring plan

Are there available resources for the site have a monitoring plan that relies on instrumentation?

If no, then monitor the site for vegetation overgrowth and site stability through regular visual inspection and finalize design of reburial system using the layers designed in the previous steps and ensure that reburial system meets both archaeological and engineering performance goals

If yes, then determine properties to monitor based on archaeological assemblage

If glass is present, then monitor for vegetation overgrowth, compression and movement

If ceramics are present, then monitor vegetation overgrowth, compression and movement

If metals are present, then monitor for pH, redox potential, electrical conductivity, moisture content, vegetation overgrowth, and movement

If bones are present, then monitor for pH, redox potential, dissolved O<sub>2</sub>, electrical conductivity, temperature, moisture content, vegetation overgrowth, compression, and movement

If wood is present, then monitor for pH, redox potential, dissolved O<sub>2</sub>, electrical conductivity, temperature, moisture content, vegetation overgrowth, compression, and movement.

Are there available resources to conduct monitoring using in ground instrumentation?

If yes, then use section 4.7.8 to determine the appropriate monitoring equipment and finalize design of reburial system using the layers designed in the previous steps and ensure that reburial system meets both archaeological and engineering performance goals

If not, construct a sampling well to procure samples for testing and finalize design of reburial system using the layers designed in the previous steps and ensure that reburial system meets both archaeological and engineering performance goals

### **5.3 Design Examples**

The following examples are included to illustrate the use of the DAISEE guidelines. Two sites were chosen for this process. First, the second Shardlow boat site was chosen to compare the constructed reburial system (which was designed by a geological engineer) to the output produced by using the DAISEE guidelines. Second, an artificial site based on the Topper site in South Carolina will be used. This site was chosen because of the large quantity of recovered archaeological material necessitates an in-situ conservation solution.

#### **5.3.1 Design Example 1**

For the first example the case history of the second Shardlow boat will be used. The remains were found during the early stages of construction for a new road in a quarry. The remains consist of a wooden Bronze Age canoe, found near the surface. The wood was found to be saturated and heavily degraded. Because the planned road design was able to be altered to avoid the archaeological site, there will be no overlying construction and the reburial will be placed in an unused section of the quarry.

### Step 1

Because we don't know the exact decay state of the boat, some assumptions need to be made. Assuming that "heavily degraded" is equivalent to having lost 50 % of original mass, then:

Material	Condition	Percentage in Assemblage
Wood	50 %	100 %

### Step 2

Calculating the sensitivity factors, we have  $S_L = 0.6$ ,  $S_{pH} = 0.6$ ,  $S_{O_2} = 1$ , and  $S_{redox} = 0.4$ . Since the infiltration rate to the archaeological layer should stay the same (no post-reburial use) then:

$$N_E = 1 * \left( \frac{0.6 + 0.4 + 1}{3} \right) = 0.67$$

### Step 3

Because we have saturated historical wood, it is imperative that the archaeological material stay saturated. Because of this, a leaky pipe irrigation system should be installed above the remains.

### Step 4

As  $N_E = 0.67$ , the DAISEE guidelines do not recommend using an infiltration barrier. Due to the sensitive nature of the archaeological material it is imperative that a wet anaerobic burial environment be provided to the archaeological material. However, this can be achieved by placing the materials at least 40 cm (1.3 feet) under the surface (Björddal et al. 2000).

#### Step 5

Because the reburial will be places in an unused section of the quarry, there is no need for protection from macro-organisms, vandalism, construction impacts, or root penetration. However, protection from erosion is necessary so a 1 foot layer or organic soil should be used as a cap to promote the growth of shallow rooted vegetation.

#### Step 6

Because there is currently no separation between the archaeological material and the irrigation system, a separation layer should be placed directly on the Shardlow boat. As the remains need to be kept saturated, a permeable layer should be used, thus a non-woven, needle-punched geotextile is most appropriate.

#### Step 7

Because there is no overlying construction, and the archaeological material is near the surface, the thickness of fill should be decided based on site conditions. However, since establishing anaerobic conditions is critical for the preservation of the archaeological material, fill thickness should be at least 1.3 feet. Since the material is sensitive to chemical processes both cohesive soils and wood fiber should be eliminated from the possible fills.

With the available information, an in-situ soil layer 1.5 feet thick is recommended for use as fill.

#### Step 8

As there will be no overlying construction, no reinforcement is necessary.

#### Step 9

The monitoring program should be decided based on the desired preservation outcomes, and the available budget. Based on the previous steps, the proposed reburial system design is presented in Figure 5.2.

#### Comparison of reburial systems

The design proposed by using the DAISEE guidelines is very different that the one that was actually constructed. However, both designs have the same goal, which is to ensure full saturation of the archaeological remains. While the constructed reburial system achieves this by placing a low permeability clay bund around the archaeological material, the DAISEE guidelines suggest instead using an irrigation system. Both designs are thin reburial covers as the remains are close to the surface, however only the DAISEE proposed design specifically calls for an erosion control solution, in the shape of vegetation cover supported by a soil cap.

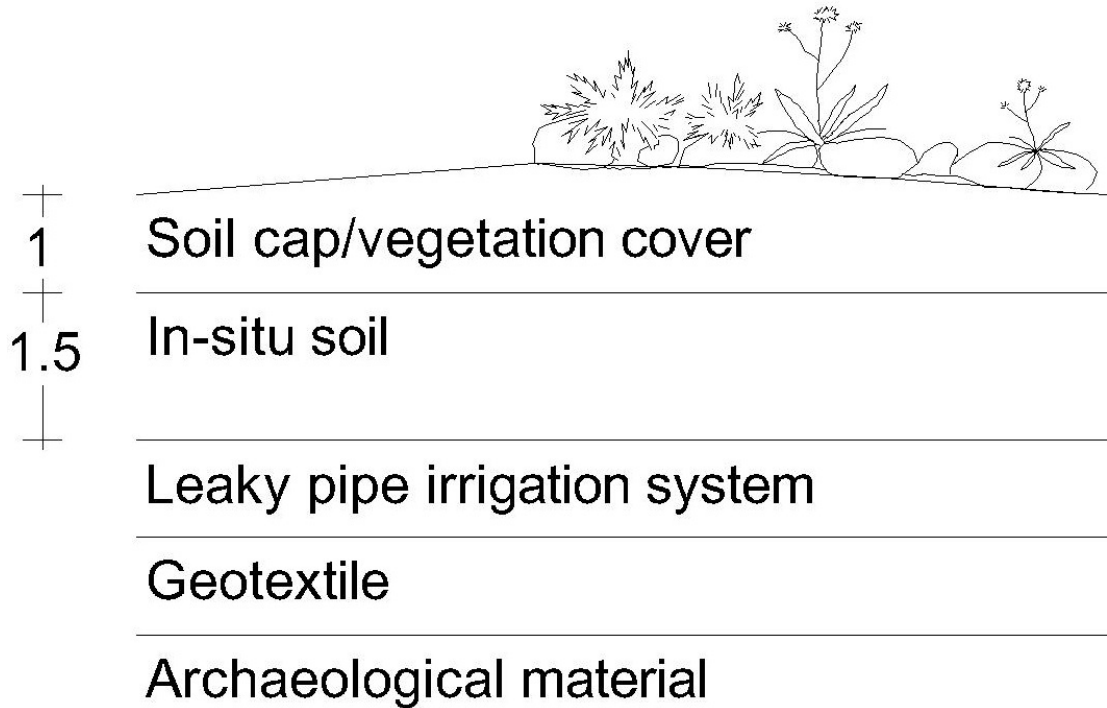

Figure 5.2 Proposed reburial system for the second Shardlow boat using the DAISEE guidelines

### 5.3.2 Design Example 2

The second site chosen for an example, is an artificial site based on the Topper site in South Carolina. In the original Topper site, stone fragments from knapping have been found extensively. Due to the demands of curating this vast assemblage, reburial of the artifacts has been considered as an alternative. The remains will be placed at an approximate depth of 4 feet under the surface, and logging trucks are expected to travel over the reburial system. There is minimal burrowing activity from macro-organisms.

Because the DAISEE guidelines has no provisions for the conservation of stone artifacts, the assemblage will be replaced by an equal mixture of glass and ceramic fragments.

### Step 1

Assuming an equal distribution of glass and ceramic, and that all the remains are shards and sherds, then:

Material	Condition	Percentage
Glass	1	50 %
Ceramic	1	50 %

### Step 2

Calculating the sensitivity factors, we have  $S_L = 1$ ,  $S_{pH} = 0$ ,  $S_{O_2} = 0$ , and  $S_{redox} = 0$ .

Since the infiltration rate to the archaeological layer should stay the same (no post-reburial use) then:

$$N_E = 1 * \left( \frac{0 + 0 + 0}{3} \right) = 0$$

### Step 3

Because the archaeological assemblage is composed of glass and ceramic, no drainage or irrigation systems are needed.

### Step 4

Since  $N_E = 0$ , no infiltration barrier is required.

#### Step 5

Although the assemblage is sensitive to load ( $S_L = 1$ ), it will be placed at a depth of 3 feet. Because of this a protection layer is not necessary to protect the archaeological material from the impact of the logging trucks. As the site is located in a rural area, vandalism will not be an issue. This, coupled with the lack of burrowing organisms, means that a protection layer against these activities is not necessary. As there will be construction overlying the reburial system (the logging road) protection layers for root penetration and erosion are not necessary.

#### Step 6

Because there is currently no separation between the archaeological material and the reburial system, a separation layer should be placed directly on the assemblage. As flexibility to conform to the archaeological layer and cushioning are both beneficial, a non-woven, needle-punched geotextile is most appropriate.

#### Step 7

As the logging road will be placed directly on top of the reburial system, the fill needs to be load bearing. This eliminates ESCS, expanded clay pellets, and vermiculite as fill materials. With the available information, an in-situ soil layer 4 feet thick is recommended for use as fill.



## Step 8

Because of the demands placed on the reburial system by the overlying logging road, reinforcement may be necessary. If reinforcement is necessary, a geotextile or geogrid reinforcement that meets the needs of the site should be designed.

## Step 9

The monitoring program should be decided based on the desired preservation outcomes, and the available budget. Based on the previous steps, the proposed reburial system design is presented in Figure 5.3

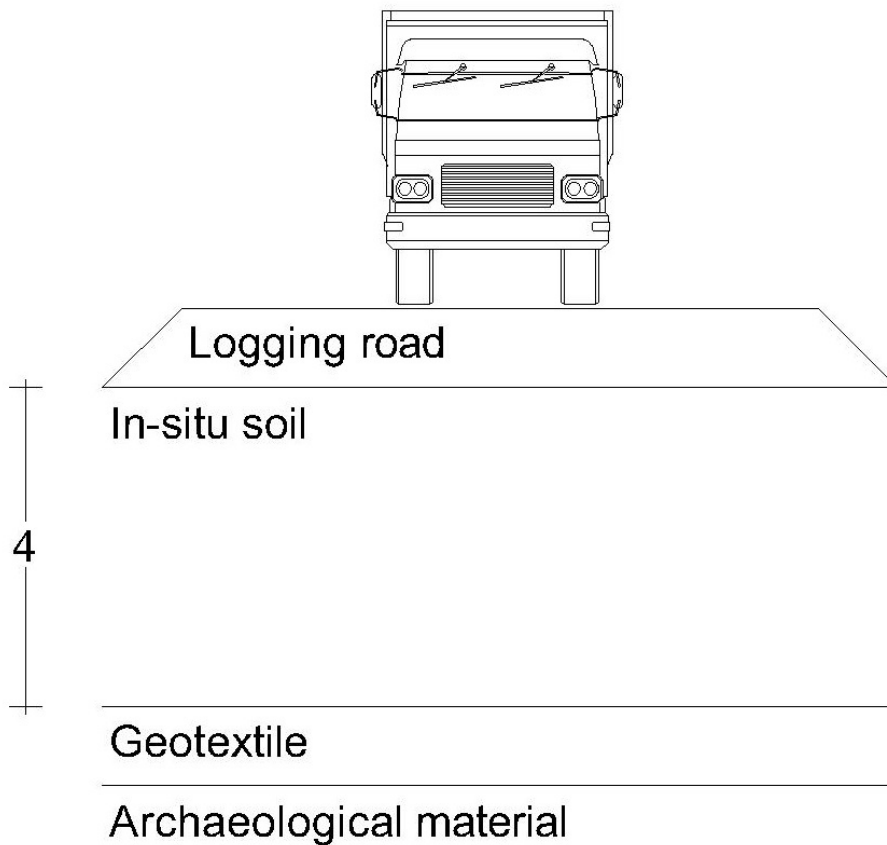

Figure 5.3 Proposed reburial system for an artificial site based on the Topper site using the DAISEE guidelines

## CHAPTER 6 CONCLUSIONS AND RECOMMENDATIONS

### 6.1 Conclusions

From the work performed, we can draw the following conclusions to answer the research questions presented:

a.) How can the current state of collaboration between the archaeological and engineering communities be summarized and how should the communities work together?

As civil engineers are often the first discoverers of an archaeological site due to construction activities, the engineering community must be aware of the preservation needs of archaeological material, the legal responsibilities towards the conservation of the site, and the preservation alternatives available. This can only be achieved by promoting greater cooperation between the archaeological and the engineering communities. Currently, in-situ conservation is the preferred treatment option for archaeological sites. Reburial allows both for an effective in-situ preservation scheme and for the continued development of the site if properly designed. Because reburial systems must meet both archaeological conservation goals and engineering performance goals, it is critical that both communities be involved in the development of the design method.

Currently, cooperation between the communities is lacking. Instead of taking an integrated approach to the preservation of archaeological sites under the threat of construction related

damage, archaeologists and engineers work separately. More cooperation, both on and off the field is necessary to optimize both the conservation and construction processes.

As the concern over the loss of archaeological information due to development has developed, legislation has been put into place in many places of the world to protect archaeological sites. Currently, varying levels of protection are afforded to archaeological sites in different countries. European countries (U.K., Norway, and Sweden) allow for the protection of archaeological material wherever it is to be disturbed. However, U.S. legislation only protects archaeological sites which are found on public land, or on projects where public funding is used; allowing for the disturbing of archaeological sites on private land. As archaeological sites can be found virtually anywhere, a more thorough degree of protection is needed to prevent loss of historical information.

b.) How are reburial systems categorized and how should reburial systems be described and classified?

Classification of reburial systems is another area in which improvement is needed. Currently, reburial systems are commonly classified based on their intended duration (temporary vs permanent). A better taxonomy is needed, as classifying systems based on intended duration is not the optimal solution for two reasons. First, this classification provides no information as to the nature of reburial systems; as a temporary reburial system will have to meet the same conservation and engineering performance goals than a permanent one. Second, the intended duration of reburial is often different than the actual duration of reburial. Because of urban development needs and budget shortfalls, often an intended temporary scheme is forced to become permanent. Vice versa, an intended

permanent reburial may be re-excavated due to research or development needs. The Rose Theatre is an excellent example of how length of reburial is hard to determine. To address these issues, a new classification system is proposed. This taxonomy was constructed to help the design process, as the reburial systems are classified on both their intended purpose, and the level of complexity of the system itself. This approach allows for a more design centered taxonomy, which is dependent on function and construction of the reburial system.

c.) What is the state of practice regarding reburial systems, and how does it compare to the state of the art?

In its current state reburial practice is fragmented, which is evidenced in places such as the lack of agreement on nomenclature. Terms like “reburial”, “backfilling”, “burial-in-place”, are all used, often interchangeably, to denote the same preservation treatment. The proposed nomenclature in this document is to use “reburial system” to mean a designed ground cover, able to be placed partially or over a full site; whether excavated, unexcavated, or at any point in between; which means to provide a reburial environment conducive to the preservation of archaeological remains while meeting the demands placed on the site post construction. Backfilling is then defined as placing fill material in open excavations with the only purpose of providing an even ground surface. In backfilling, the preservation of the archaeological material or the post-burial needs of the site are not designed for.

Because the reburial movement is a relatively recent one, much of the present knowledge comes from real world experiences with this in-situ conservation option. Reburial designs

that are implemented across the world are either a “common practice” scheme which does not take into account the site conditions, or a scheme specifically designed for the site. These site specific designs are often developed by the archaeologist in charge of the conservation treatment, who may or may not have the necessary engineering knowledge, or experience with reburial, that is needed. Although there have been some efforts to develop design guidelines, and some guidance is available, there is no accepted design method for archaeological reburial systems.

As reburial system design guidelines are currently being developed, it is critical that real world reburial experience be used to inform the design process. Reburial systems should be monitored to ensure that they meet both archeological and engineering performance goals, and the results should be published. Case histories should be detailed and include all necessary information for the design of the reburial system, like archaeological assemblage composition and state, engineering demands placed on the site, detailed site conditions, and other data pertinent to design.

d.) How should reburial systems be designed and which guidelines should be followed?

To standardize archaeological reburial systems, design guidelines must be proposed, and accepted in both the archaeological and engineering communities. A complete design method should quantify the archaeological assemblage composition and condition, while also allowing to prioritize the conservation of a subset of the assemblage, and use that information as input. The engineering characteristics of the site (soil properties, subsurface hydrology regime, etc...) must also be accounted for in the design process. Lastly, any demands placed on the archaeological site post-burial must be considered, and their impact

on the preservation of the buried archaeological material must be characterized. Quantifiable performance goals for both conservation and engineering performance must be set, and the design process should produce a reburial system that meets those goals.

The DAISEE guidelines consist of a first step towards that goal. Through the proposed sensitivity equations, these guidelines seek to quantify the variety and current state of the archaeological material, and to determine the likelihood of damage when exposed to a certain condition. The DAISEE guidelines assume a “standard reburial system” in which each component seeks to provide protection to the archaeological material from a specific source of damage. Each component can be designed (or removed) based on both the archaeological material which is to be preserved, and the specific site conditions. However, more work needs to be performed for the DAISEE guidelines to transform into a complete design method.

## **6.2 Future Work**

In order to develop a complete design method for reburial systems, three challenges need to be overcome. These challenges are:

- a.) Lack of a quantifiable understanding of the decay processes of buried archaeological material and the interactions between the archaeological material and the burial environment
- b.) Lack of quantifiable preservation goals for the buried archaeological material, and
- c.) Lack of real-world, long term performance data of reburial systems

As the completion of a design method is contingent on these challenges, research efforts in both the archaeological and engineering communities should be directed towards overcoming these challenges.

Providing a clear understanding of the decay processes of buried archaeological materials and the interactions between the material and the burial environment is critical to the development of a complete design method. Currently, we have only a qualitative understanding of the impact of different burial conditions on the survival of archaeological remains. Although we know an acidic environment is detrimental to the survival of bone artifacts, the specific ranges for conservation need to be established. Having a better understanding will also allow for the determination of more appropriate factors for the site sensitivity equation. Overcoming this challenge is necessary before quantifiable preservation goals can be established.

Once the decay processes of archaeological material are better understood, quantifiable preservation goals for archaeological material must be established. These goals should be determined for a wide range of archaeological material under a wide range of conditions. Mathewson's artifact decay matrix can provide an excellent starting point. By replacing the qualitative assessment present in the matrix with quantifiable ranges, quantifiable performance goals for a reburial system can be set depending on the archaeological material to be protected. Once specific performance goals have been set, the reburial system can be engineered to provide a burial environment within the desired parameters.

Lastly, the publication of more reburial case histories should be encouraged; especially if the DAISEE guidelines are used. These publications should be very detailed in the nature

of the archaeological material to be protected, the engineering demands placed on the reburial system, and the site conditions at the time of reburial. Reburial systems should be monitored to ensure the continued protection of the archaeological material, and to assess the effectiveness of the reburial scheme in protecting the remains. The monitoring data should be analyzed and published in order to inform future designs of reburial systems and the design method. The case histories need to be published in venues accessible to both archaeologists and engineers.

### **6.3 Recommendations**

Based on the work performed for this dissertation, the following recommendations are used:

**a.) There should be a higher degree of collaboration between the archaeological and engineering communities:** As civil engineers are often responsible for the discovery and survival of archaeological sites, more collaboration is needed to ensure that both archaeological and engineering goals are met. This can range from accommodating preliminary archaeological testing to determine the existence of archaeological material at the site, to planning construction activities to allow salvage archaeology to be performed at the site with minimal disturbance to both engineering and archeological work, to the development of design guidelines for reburial or other in-situ conservation techniques. Both field engineers and archaeologists need to be aware of the needs of the other community and the legal framework in which they operate. This can be achieved by raising awareness about the need for collaboration through joint research and publication.



**b.) A classification system based on reburial system performance must be adopted:**

Current classification of reburial systems is based on the intended length of burial. As this is liable to change, and does not provide any pertinent information for design, a better taxonomy is needed. The proposed classification system divides reburial system based on their intended purpose (protection from either mechanical or chemical sources) and their level of complexity (how many components are in the system). The classification of the system is then dependent on both the archeological material to be preserved, and the engineering demands placed on the site. This taxonomy, which is performance and construction oriented, provides more information about the reburial system and is more design-oriented.

**c.) More research should be performed to better understand, and quantify, the processes occurring in a reburial system:**

Quantitative research into the processes affecting buried archaeological material is necessary to the development of a complete design method. This can be performed in the laboratory, in full scale field tests, or by computer modelling. Quantifiable performance goals for a reburial system must be established and used to guide the design of reburial systems. Real world long term performance data should also be made available to both assess the current state of design, and inform future design methods.

**d.) The DAISEE guidelines should be refined with the goal of developing a complete design method:**

In order to refine the DAISEE guidelines, a better understanding of the processes in a burial environment must be attained. However, peer review of the guidelines coupled with performance data from real world applications of the guidelines should be

used to refine the system as well. This should be achieved by increasing the visibility of the DAISEE guidelines through publications and presentations.

## REFERENCES

- Agnew, N., Barrow, J., Demas, M., Ford, D., Roby, T., Stanley-Price, N., Romero Taylor, M., and Teutonico, J. M. (2004). "Reburial of archaeological sites: A colloquium organized by the Getty Conservation Institute, the National Park Service (Intermountain Region) and ICCROM." *Conservation and Management of Archaeological Sites*, 6, 133–135.
- Agnew, N., Selwitz, C., and Demas, M. (2004). "Reburial research: preliminary field experiments at Fort Selden." *Conservation and Management of Archaeological Sites*, 6, 333–345.
- Ashurst, J., Balaam, N., and Foley, K. (1989). "The Rose Theatre Overcoming the Technical Preservation Problems." *Conservation Bulletin*, (9), 9–10.
- Banwart, S. A. (1998). "Groundwater geochemistry in the burial environment." *Preserving archaeological remains in situ : proceedings of the conference of 1-3 April 1996*, 66–72.
- De Beer, E. E. (1970). "Experimental Determination of the Shape Factors and the Bearing Capacity Factors of Sand." *Geotechnique*, 20(4), 387–411.
- Bergstrand, T. (2002). "In situ preservation and re-burial, -methods to handle archaeological ship remains in the archipelago of Göteborg, Sweden." *Proceedings of the 8th ICOM group on wet organic archaeological materials conference*, 155–166.
- Biddle, M. (1989). "The Rose reviewed: a comedy (?) of errors." *Antiquity*, 63(241), 753–760.
- Bilsbarrow, M. H. (2004). *SHPO Position on Burial-in-Place Treatment for Archaeological Sites*. 1–16.
- Björdal, C. G., Daniel, G., and Nilsson, T. (2000). "Depth of burial, an important factor in controlling bacterial decay of waterlogged archaeological poles." *International biodeterioration & biodegradation*, Elsevier, 45(1-2), 15–26.
- Björdal, C. G., and Nilsson, T. (1998). "Laboratory reburial experiments." *Proceedings of the 7th ICOM-CC working group on wet organic archaeological materials conference, Grenoble, France= Actes de la 7ème conférence du groupe de travail*

*Matériaux archéologiques organiques humides de l'ICOM-CC, Grenoble, France, Arc-Nucléart, 71–77.*

- Björdal, C. G., and Nilsson, T. (2007). *Appendix 4 - Reburial experiment in the harbour of Marstrand: Degradation of Wood. gotbot.se, Helsinki, 1–14.*
- Brand, E. W., and Pang, P. L. R. (1991). “Durability of Geotextiles to Outdoor Exposure in Hong Kong.” *Journal of Geotechnical Engineering*, American Society of Civil Engineers, 117(7), 979–1000.
- Brandenberg, S. J., Coe, J., Nigbor, R. L., and Tanksley, K. (2009). “Different Approaches for Estimating Ground Strains from Pile Driving Vibrations at a Buried Archeological Site.” *Journal of Geotechnical and Geoenvironmental Engineering*, 135, 1101.
- Burch, R. (2004). “Selected Papers from the colloquium ‘Reburial of Archaeological Sites.’” *Conservation and Management of Archaeological Sites*, 6(3&4), 133–399.
- Burch, R., and Agnew, N. (2004). “Reburial research: a conceptual design for field testing for the reburial of wall plasters and mosaic pavements.” *Conservation and Management of Archaeological Sites*, 6(3/4), 347–361.
- Canti, M. G., and Davis, M. (1999). “Tests and guidelines for the suitability of sands to be used in archaeological site reburial.” *Journal of archaeological science*, Elsevier, 26(7), 775–781.
- Caple, C. (1994). “Reburial of waterlogged wood, the problems and potential of this conservation technique.” *International biodeterioration & biodegradation*, Elsevier, 34(1), 61–72.
- Caple, C. (2004). “Towards a benign reburial context: the chemistry of the burial environment.” *Conservation and Management of Archaeological Sites*, 6(3&4), 155–165.
- Carroll, R. G. J. (1983). “Geotextile Filter Criteria.” *TRR*, 916(Engineering Fabrics in Transportation Construction), 46–53.
- Chang, M., Yu, G., Na, Y., and Choa, V. (2006). “Evaluation of relative density profiles of sand fill at a reclaimed site.” *Canadian Geotechnical Journal*, 43(9), 903–914.
- Chesner, W., Collins, R., and MacKay, M. (1998). *User guidelines for waste and by-product materials in pavement construction.*
- Chippindale, C. (1989). “Editorial.” *Antiquity*, 63(240), 411–420.

- Corfield, M. (1996). "Preventive conservation for archaeological sites." *Archaeological conservation and its consequences*., International Institute for Conservation, London, 32–37.
- Corfield, M. (2004). "Saving the Rose Theatre: Englands first managed and monitored reburial." *Conservation and Management of Archaeological Sites*, 6, 305–314.
- Corfield, M. (2012). "The Rose Theatre: Twenty Years of continuous monitoring, lessons and legacy." *Conservation and Management of Archaeological Sites*, 14((1-4)), 384–396.
- Crowther, J., Macphail, R., and Cruise, G. (1996). "Short-term, post-burial change in a humic rendzina soil, Overton Down Experimental Earthwork, Wiltshire, England." *Geoarchaeology*, 11(2), 95–117.
- Curci, J. (2006). "The reburial of waterlogged archaeological wood in wet environments." *Tech. Briefs Histor. Archaeol*, 1, 21–25.
- Daniel, D. E., and Koerner, R. M. (1993). *Quality Assurance and Quality Control for Waste Containment Facilities*. 305.
- Daniel, D. E., Shan, H. Y., and Anderson, J. D. (1993). "Effects of Partial Wetting on the Performance of the Bentonite Component of a Geosynthetic Clay Liner." *Proceedings of Geosynthetics '93*, Industrial Fabrics Association International, St Paul, MN, Vancouver, 1483–1496.
- Das, B. M. (2002). *Principles of geotechnical engineering*. Brooks Cole/Thompson Learning, 589.
- Das, B. M. (2010). *Principles of foundation engineering*. Cengage Learning, 816.
- Demas, M. (2004). "Site unseen: the case for reburial of archaeological sites." *Conservation and Management of Archaeological Sites*, 6(3&4), 137–154.
- Demas, M., Agnew, N., Waane, S., Podany, J., Bass, A., and Kamamba, D. (2003). "Preservation of the Laetoli hominid trackway in Tanzania." *Archaeological conservation and its consequences Preprints of the contributions to the Copenhagen Congress 1996*, A. Roy and P. Smith, eds., Rome, 38–42.
- Department for Communities and Local Government. (1990). *Planning Policy Guidance 16 : Archaeology and planning*.
- Department for Communities and Local Government. (1994). *Planning Policy Guidance 15 : Archaeology and planning*.

- Department for Communities and Local Government. (2010). *Planning Policy Statement 5: Planning for the Historic Environment. Buildings*.
- Duncan, J. ., Byrne, P., Wong, K. S., and Mabry, P. (1978). *Strength, Stress-Strain and Bulk Modulus Parameters for Finite Element Analyses of Stresses and Movements in Soil Masses*. Berkeley, CA.
- Dunnicliff, J. (1993). *Geotechnical Instrumentation for Monitoring Field Performance*. John Wiley & Sons, 577.
- English Heritage. (2007). "Piling and Archaeology." <<http://www.english-heritage.org.uk/publications/piling-and-archaeology/>> (Mar. 12, 2012).
- Environment Agency. (2006). *Piling in Layered Ground - Risks to Groundwater and Archaeology*. 61.
- Ford, D., and Demas, M. (2004). "Chaco Canyon reburial programme." *Conservation and Management of Archaeological Sites*, 6(3/4), 177–202.
- Fox, P. J., Rowland, M. G., and Scheithe, J. R. (1998). "Internal Shear Strength of Three Geosynthetic Clay Liners." *Journal of Geotechnical and Geoenvironmental Engineering*, 124(10), 933–944.
- Gilbert, R. B., Fernandez, F., and Horsfield, D. W. (1996). "Shear Strength of Reinforced Geosynthetic Clay Liner." *Journal of Geotechnical Engineering*, 122(4), 259–266.
- Goodburn-Brown, D., and Hughes, R. (1996). "A review of some conservation procedures for the reburial of archaeological sites in London." *Archaeological conservation and its consequences Preprints of the contributions to the Copenhagen Congress 1996*, 65–69.
- Goodburn-Brown, D., and Panter, I. (2004). "Reburial in the context of development: approaches to reburial in the English planning process." *Conservation and Management of Archaeological Sites*, Maney Publishing, 6(3-4), 275–284.
- Greenfield, J., and Gurr, A. (2004). "The Rose Theatre, London: the state of knowledge and what we still need to know." *Antiquity*, Portland Press, 78(300), 330–340.
- Gregory, D. J. (1998). "Re-burial of timbers in the marine environment as a means of their long-term storage: experimental studies in Lynaes Sands, Denmark." *International Journal of Nautical Archaeology*, Wiley Online Library, 27(4), 343–358.
- Hansen, J. B. (1970). "A revised and extended formula for bearing capacity." *Bulletin of the Danish Geotechnical Institute*, 28, 5–11.
- Hester, J. J. (1988). *Experiments on the Effects of Site Burial on Archaeological Materials*.

- Hinze, J., and Antal, T. (1991). "Construction Contract Provisions for Preservation of Artifacts." *Journal of Construction Engineering and Management*, 117(1), 106–117.
- Holtz, R. D., and Kovacs, W. D. (1981). *An introduction to geotechnical engineering*. Prentice-Hall, 733.
- Johnsen, E. (2009). "A Question of Reburial." *Sratus Report on Reburial at Archaeological Sites in Norway A Multriple Case Study MA thesis in Archaeology, Trondheim, Spring*, Norges Teknisk-naturvitenskapelige universitet.
- Kavazanjian, E. J. (2004). "The use of geosynthetics for archaeological site reburial." *Conservation and Management of Archaeological Sites*, Maney Publishing, 6(3&4), 377–393.
- Koerner, G. R., Hsuan, G. Y., and Koerner, R. M. (1998). "Photo-Initiated Degradation of Geotextiles." *Journal of Geotechnical and Geoenvironmental Engineering*, American Society of Civil Engineers, 124(12), 1159–1166.
- Koerner, R. M. (2005). *Designing with Geosynthetics*. Prentice Hall, 816.
- Lawson, T., Hopkins, D. W., Chudek, J. ., Janaway, R. ., and Bell, M. . (2000). "The Experimental Earthwork at Wareham, Dorset after 33 Years: 3. Interaction of Soil Organisms with Buried Materials." *Journal of Archaeological Science*, 27(4), 273–285.
- LeBlanc, F. (2003). *Field Trip Report Colloquium on Reburial of Archaeological Sites - Santa Fe, New Mexico*. 1–10.
- Mathewson, C. C. (1988). "Protection and Preservation of Archaeological Sites through Burial: A Multidisciplinary Problem." *Society for Applied Anthropology Meeting*, Paper on file at the Center for Engineering Geosciences, Texas A&M University.
- Mathewson, C. C. (1989a). "Interdisciplinary Workshop on the Physical-Chemical-Biological Processes Affecting Archeological Sites." .S. Army Engineer Waterways Experiment Station, 301.
- Mathewson, C. C. (1989b). "Logic-based qualitative site decay model for the preservation of archaeological sites." *Interdisciplinary Workshop on Processes Affecting Archaeological Sites*.
- Mathewson, C. C. (1989c). "Introduction to the Workshop and the Concept of a Site Decay Model." *Interdisciplinary workshop on the physical-chemical-biological processes affecting archaeological sites*, 10–14.

- Mathewson, C. C., and Gonzalez, T. (1988). "Protection and preservation of archaeological sites through burial." *The Engineering Geology of Ancient Works, Monuments and Historical Sites: Preservation and Protection*, AA Balkema: Rotterdam, 519–526.
- Mathewson, C. C., Gonzalez, T., and Eblen, J. S. (1992). *Burial as a Method of Archaeological Site Protection*. 1–125.
- McLees, C. (2008). *Olav Tryggvasons gate 3 og Krabugata 3 og 5 (Bristolkvartalet). Arekologiske undersøkelser i forbindelse med bygging av nytt hotell*.
- Meyerhof, G. G. (1963). "Some Recent Research on the Bearing Capacity of Foundations." *Canadian Geotechnical Journal*, 1(1), 16–26.
- Mora, P. (1986). "Conservazione di intonaco, stucco e mosaici scavati." *La conservazione sullo scavo archeologico: con ...*, 97–107.
- Mueller, W., Buettgenbach, B., Jakob, I., and Mann, H. (2003). "Comparison of the oxidative resistance of various polyolefin geotextiles." *Geotextiles and Geomembranes*, 21(5), 289–315.
- NASA. (2008). "NASA design process." <[http://www.nasa.gov/audience/foreducators/plantgrowth/reference/Eng\\_Design\\_5-12.html](http://www.nasa.gov/audience/foreducators/plantgrowth/reference/Eng_Design_5-12.html)>.
- Nickens, P. R. (1991a). *Perspectives on Archaeological Site Protection and Preservation*. 150.
- Nickens, P. R. (1991b). "The destruction of archaeological sites and data." *Protecting the past*, G. S. Smith and J. E. Ehrenhard, eds., CRC Press.
- Nixon, T. (1998). "Practically preserved: observations on the impact of construction on urban archaeological deposits." *Preserving archaeological remains in situ: proceedings of the conference of 1-3 April 1996*, 39–46.
- Orrell, J., and Gurr, A. (1989). "What the Rose can tell us." *Antiquity*, 63(240), 421–429.
- Palmer, M. (2005). "Understanding the Workplace: A Research Framework for Industrial Archaeology in Britain." *Industrial Archaeology Review*, 27(1), 9–17.
- Podany, J., Agnew, N., and Demas, M. (1994). "Preservation of excavated mosaics by reburial: evaluation of some traditional and newly developed materials and techniques." *Conservation of Mosaics*, 1–19.
- Qian, X., Gray, D. H., and Koerner, R. M. (2001). *Geotechnical Aspects of Landfill Design and Construction*: Prentice Hall, 717.



- Rimmer, M. B., and Caple, C. (2008). "Estimating artefact loss: A comparison of metal artefacts loss rates through in-situ decay and loss of ancient monument sites in England." *Preserving archaeological remains in situ: proceedings of the 3rd conference, 7-9 December 2006, Amsterdam*, 65–74.
- Rivera, A. B., Culpepper, B., Barrow, J., and Fisher, P. (2004). "Partial reburial of West Ruin at Aztec Ruins National Monument." *Conservation and Management of Archaeological Sites*, 6(3), 285–294.
- Roby, T. (2004). "The reburial of mosaics: an overview of materials and practice." *Conservation and Management of Archaeological ...*, 6, 229–236.
- Salvadori, M. G. (1976). "Historical Sites and the Construction Engineer." *Journal of the Construction Division, ASCE*, 102(2), 295–301.
- Salvadori, M. G., and Cortes-Comerer, N. I. (1977). "Ecology of the past - the new responsibility." *Civil Engineering*, 47(6), 61–65.
- Schleicher, F. (1926). "Zur Theorie des Baurundes." *Bauingenieur*, 7(48), 931–935.
- Shan, H. Y., and Daniel, D. E. (1991). "Results of Laboratory Tests on a Geotextile/Bentonite Liner Material." *Geosynthetics 91*, Industrial Fabrics Association International, St Paul, MN, 517–535.
- Shilston, D. T., and Fletcher, S. L. (1998). "Geotechnical engineering for the in situ preservation of archaeological remains." *Preserving archaeological remains in situ: proceedings of the conference of 1-3 April 1996*, 8–15.
- Sidell, E. J., Higuchi, T., Allison, R. J., and Long, A. J. (2004). "The response of archaeological sediments and artefacts to imposed stress regimes as a consequence of past, present and future anthropogenic activity." *Preserving archaeological remains in situ: proceedings of the 2nd conference, 12-14th September 2001*, 42–49.
- Stewart, J. (2004). "Reburial of Excavated Sites Conservation and management." *English Heritage Conservation Bulletin*, (45), 28–29.
- Stewart, J., Murdock, L. D., Waddell, P., Vandiver, P. B., Druzik, J. R., Galván Madrid, J. L., Freestone, I. C., and Wheeler, G. S. (1995). "Reburial of the Red Bay Wreck as a form of preservation and protection of the historic resource." *Materials Research Society symposia proceedings (v. 352)*, Materials Research Society, 791–805.
- Terzaghi, K. (1943). *Theoretical Soil Mechanics*. John Wiley & Sons, New York, 510.
- Thorne, R. M. (1991a). "Intentional Site Burial: A Technique to Protect against Natural or Mechanical Loss." *Technical Brief No. 5*, Archaeological Assistance Program Technical Brief No, 5.

- Thorne, R. M. (1991b). "Site Stabilization Information Sources." *Technical Brief No. 12*, Archaeological Assistance Division Technical Brief No. 12, 1–8.
- Tilly, G. P. (1998). "Engineering Methods of minimising damage and preserving archaeological remains in situ." *Preserving archaeological remains in situ : proceedings of the conference of 1-3 April 1996*, 1–7.
- Tsirk, A. (1979). "Archeological Resources, Planning, and Construction." *Journal of the Construction Division*, 105(1), 79–94.
- Vesic, A. S. (1973). "Analysis of Ultimate Loads of Shallow Foundations." *ASCE Journal of Soil Mechanics and Foundations Division*, 99, 45–73.
- Wainwright, G. J. (1989). "Saving the Rose." *Antiquity*, 63, 430–435.
- Welch, J., and Thomas, S. (1998). "Groundwater modelling of waterlogged archaeological deposits." *Preserving archaeological remains in situ : proceedings of the conference of 1-3 April 1996*, 16–20.
- Wildesen, Leslie E. (1982). "The Study of Impacts on Archaeological Sites." *Advances in Archaeological Methods and Theory*, 5, 51–96.
- Williams, J., Bacon, H. M., Onions, B., Barrett, D., Richmond, A., and Page, M. (2008). "The Second Shardlow boat - economic drivers or heritage policy?" *Preserving archaeological remains in situ : proceedings of the 3rd conference, 7-9 December 2006, Amsterdam*, 317–325.
- Williams, J., and Butcher, A. (2006). *Foundation re-use as a mechanism for the preservation of buried cultural heritage in urban centres: how new engineering research helps limit archaeological damage*.
- Williams, J., and Corfield, M. (2002). "Construction impacts on in situ preservation of archaeological sites and artefacts." *Proceedings of the 5th European Commission Conference on Cultural Heritage Research: A Pan European Challenge, Cracow*, 16–18.